



特约省份一级经销：
Provincial initial distributors



移动布菲产品系列
Mobile buffet series



本厂创建於 1965 年并在香港开始制作金银器餐具产品，由传统的纯手工打制发展为集现代电子机械设备、激光科技设备于一身的现代化企业。严谨的表面电镀工艺处理成就每一件金银器餐具，高品质的产品享誉酒店管理公司及海内外中东皇室贵族认可。

SGG 研制的自助餐产品可提供无数可能的创意去展示食物的吸引力和高度可灵活搭配，创造档次与无限空间。在研发过程中，*SGG* 非常注重自助餐产品的兼容性，每个产品的线条，外观兼具创意与构思。

SGG 秉承创新精神，将传统和创意相结合，将尽最大的努力把“华丽”和“光亮”带到餐桌与艺术主题的自助餐空间里。更使 *SGG* 的品牌成为行业之最。

Our company founded in 1965 in Hongkong, from the manual manufacture of the technicians of the old generation in the beginning to fully mechanized plunger to day, from processing of manufactured body in the beginning to the productive enterprise entity in integrating manufaction, production, surface-electroplating processing, development & research and marketing into itself, manufacturing professionally the gold and silver tableware and buffetwane.specialized in making silver wares and stainless steel buffetwares.

SGG offers innumerable possibilities to present food optially appealing and highly flexible, provides level and freedom. When developing mew products ,it is of high importance for *SGG* to considerate the compatibility among the individual systems. All products consist of creativities and concepts .

Tradition and creativity combined ,it gives us creativity and flexibility .We will continue to make all efforts to bring "gorgeous" and "shiny" to the dining tables and "art buffet ".



长期合作伙伴
Reference



BUFFET





传承与发展
Inheritance and Development

我们公司的产品线: Our Product Lines:



移动布菲车产品系列
Mobile Buffet Station Series



高档次三层材料餐厨锅系列
High-class Three-ply Cookware Series



西式餐具桌面系列
Western Style Tableware Series



银器餐具桌面系列
Silver Plated Tableware Series



中东皇室金银器餐具系列
Middle-Eastern Royal Gold & Silver Plated Tableware Series



自助餐 (Buffet) 摆件系列
Buffet Display Series



中式金器餐具桌面系列
Chinese Style Gold Plated Tableware Series



酒店级别的镀银、耐磨
Hotel-grade Silver Plating
Technology, Abrasion
Resistance



三层锅材料制造
外观极致完美
Three-ply Pots With
Extremely Perfect
Design

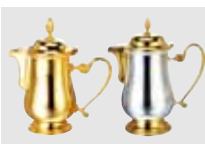

极致美感造工
实用性、收藏性
Perfect Workmanship,
High Practicability And
Collection Value



个性化定制产品
雕刻、冲制 Logo
Personalized
Customization, Engraved
& Embossed Logos



实木制品选材严谨、
传统榫工艺
Solid Wood Products,
Strictly Selected Raw
material, Traditional Tenon
Connecting Craft



手工打制、皇室
极尽奢华、尊贵
Handcraft, Extremely
Luxurious&Noble

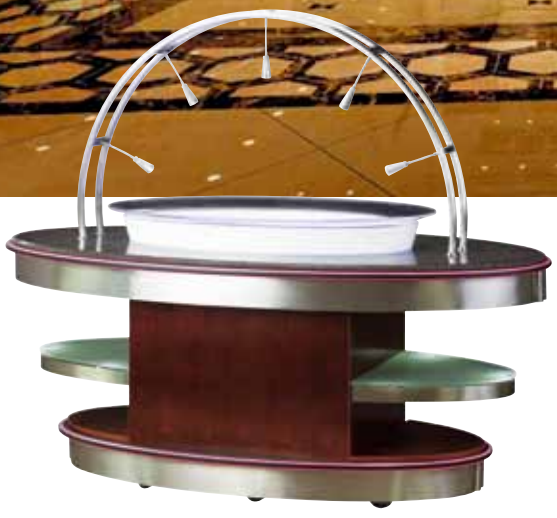

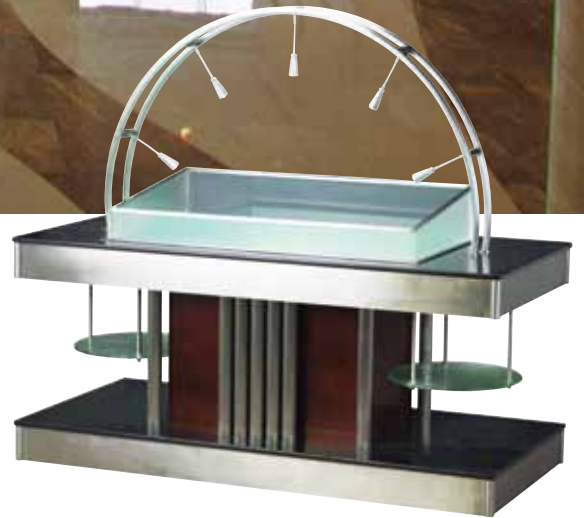



移动布菲系列
Mobile buffet series

001-045



茶歇台系列
Tea break series

046-067



屏风系列
Screen series

068-075



餐车系列
Dinner series

076-087



户外可移动售卖车系列
Refreshment Trailer series

088-089



LED系列
LED series

090-094

Product list to page: **P095-096**

产品清单所在页面

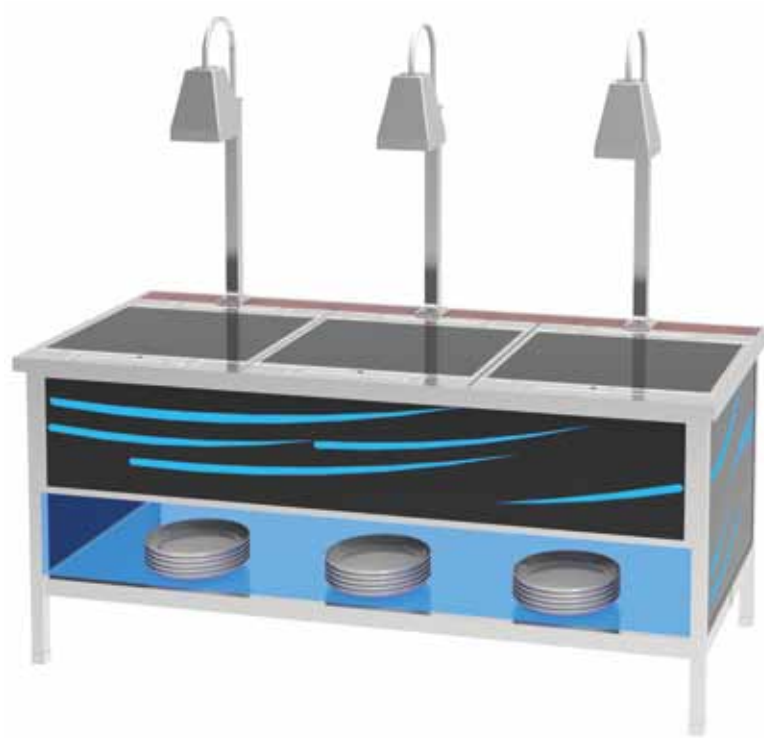

Color For Wood Grain
台面木纹选项

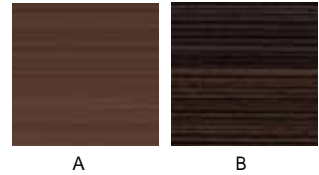

Color For Marble
台面大理石选项

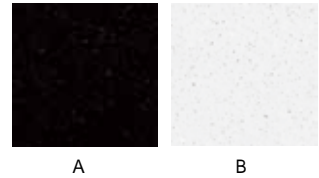

Please pay attention that this design is with wheels or without wheels.
请注意，此设计分为配轮和不配轮

Foldable design, solve the space problem. Module could be free composited. The convenient handle is easy for moving, much suitable for customer.



SCC.A-JA1



SCC.A-JA2

折叠设计，解决了空间不足的问题。模块可自由组合，配置便捷挽手，方便模块的移动。更符合使用者的需求。



SCC.A-JA 嵌入式折叠系列

Build-in Foldable Series



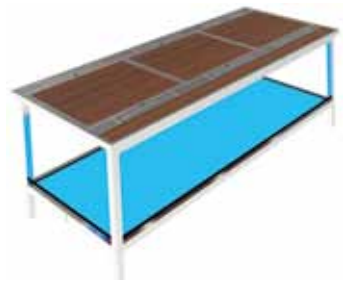
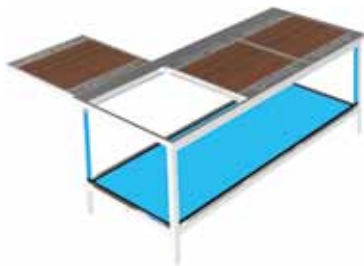
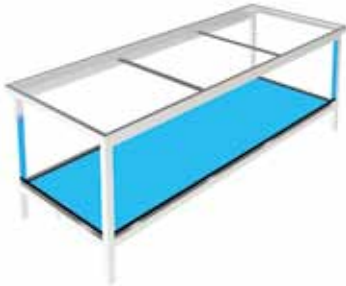

SCC.A-JB 模块式折叠系列

Modular Foldable Series

Product list to page: **P097-098**

产品清单所在页面



Color For Wood Grain
台面木纹选项



A

B

Color For Canvas
帆布选项



A

B

C

Foldable design, solve the space problem.
Different module satisfy each customer.
Simplicity and generosity.

可折叠设计，解决布菲车占用太多地方的问题。
配置不同模块，满足不同客户的需求。外观简洁，大方。





SCC.A-JC 七彩星光系列

Colorful Light Star Series

Product list to page: **P099**

产品清单所在页面

Steel structure, side board is acrylic or veneer. Hollow pattern and colorful light make more style.

不锈钢框架结构，采用亚克力板或者防火板作为侧板。可配置镂空花纹不锈钢。与七彩灯光的配合，组合出更多风格。

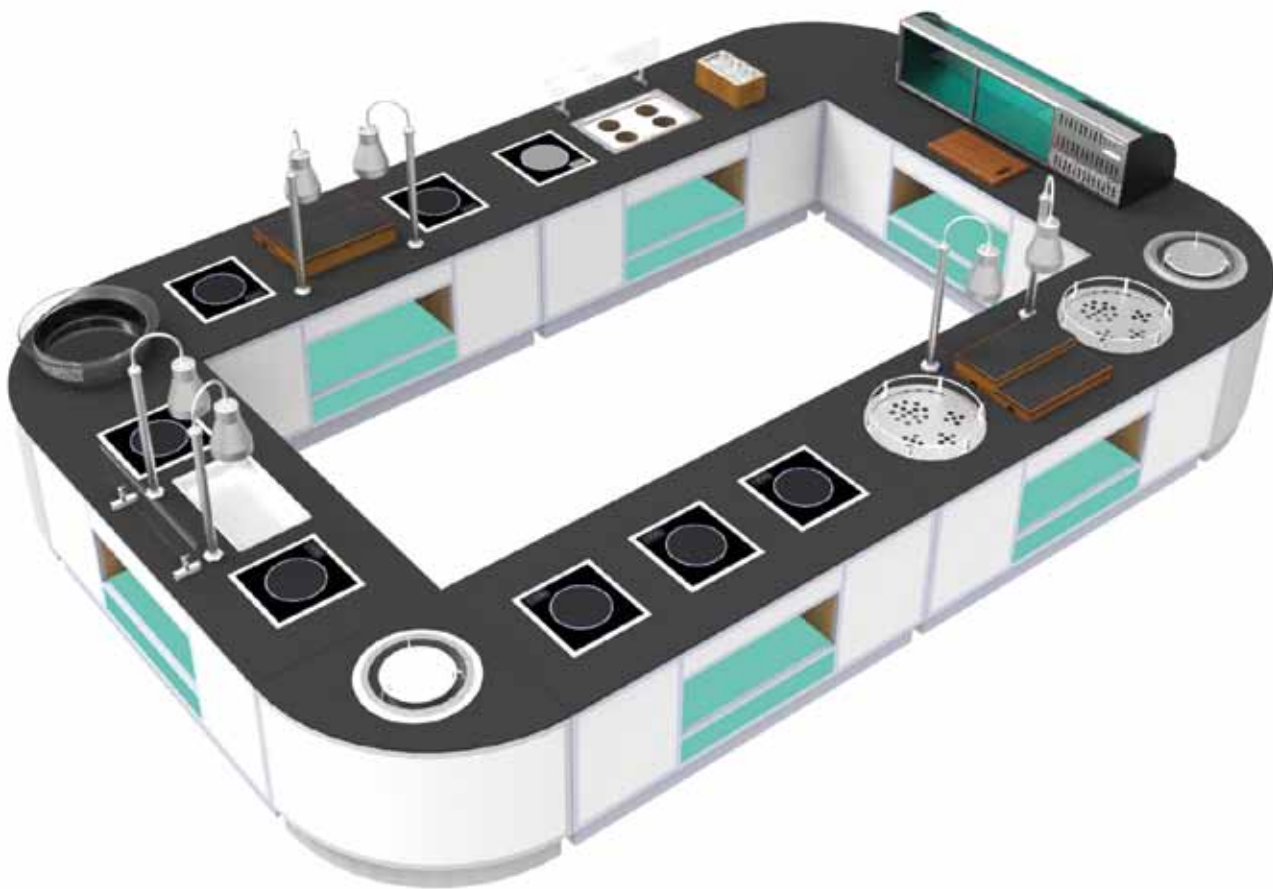



Design 1
款式一



Design 2
款式二

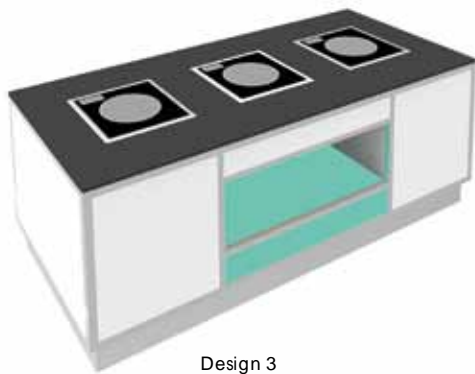

Design 3
款式三



Design 4
款式四



Design 5
款式五

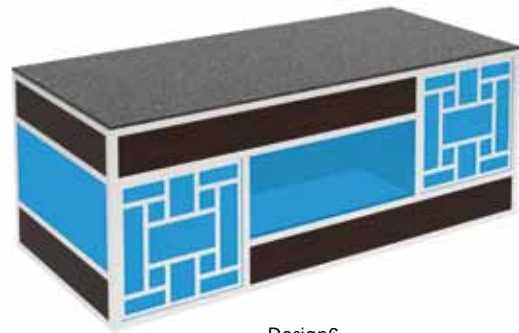

Design 6
款式六

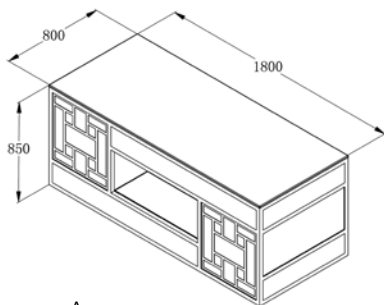

A:
standard station
标准台

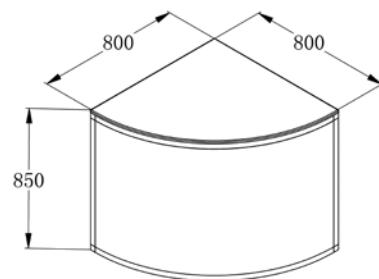

B:
side station
附台

SCC.A-JD 时尚太极系列

Fashion Tai-Ji Series

Product list to page: **P100**

产品清单所在页面

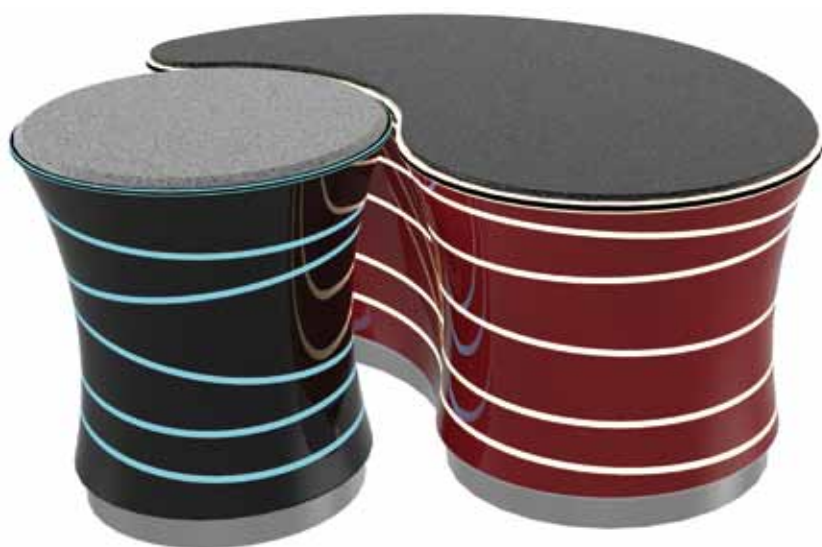

Color For Marble
台面大理石选项

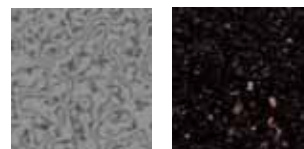

A

B

The design philosophy is based on Chinese Tai-Ji. It change the general appearance of the ordinary buffet stations. With its wave line LED and abnormal structure it can be set up flexibly and combined freely.

以中国太极为基础，改变普通布菲车的外形结构。可自由摆放，自由组合。带流水曲线的LED。

Color For Surface Material
表面材质选项



A

B

C

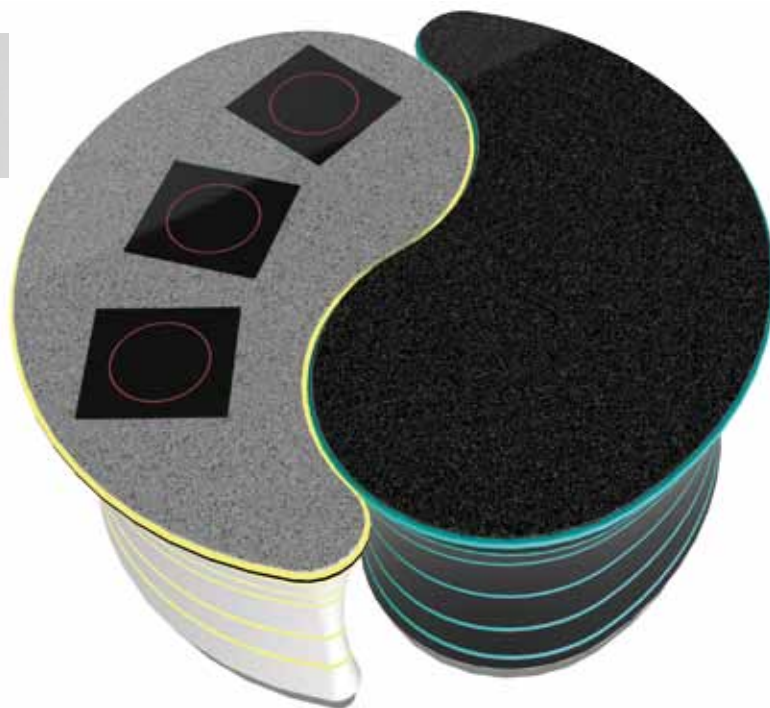

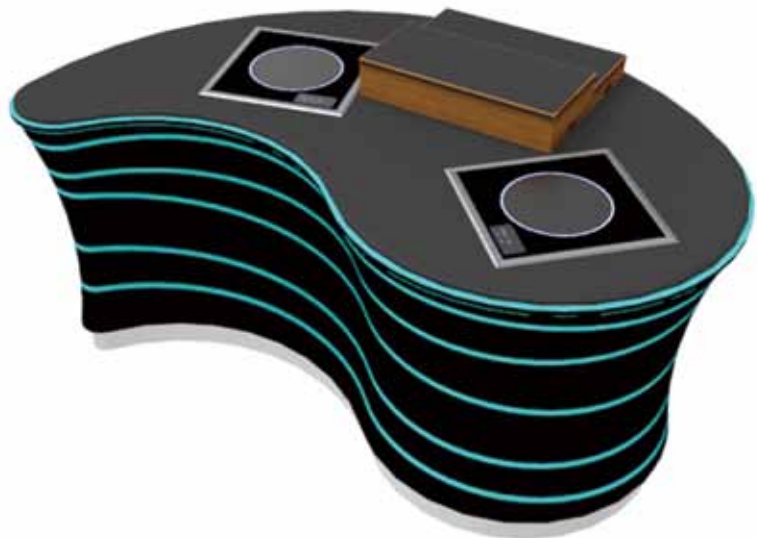
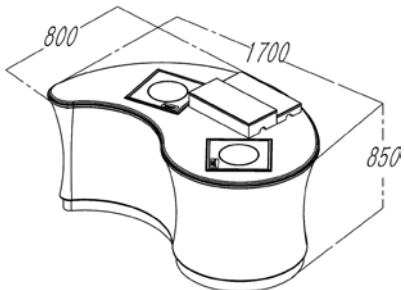
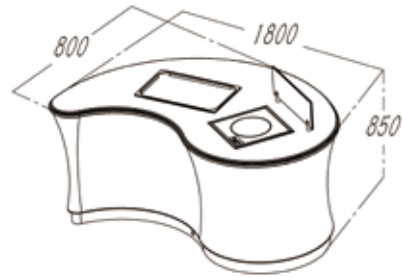
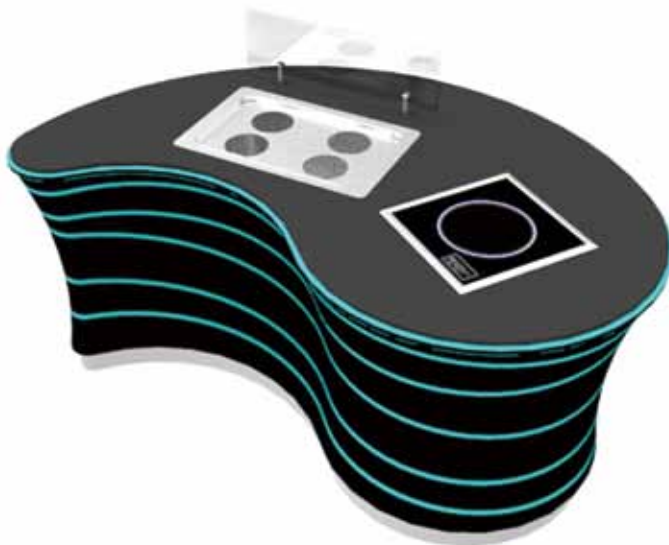

SCC.A-JE 梦幻海洋系列

Fantasy-Sea Series

Product list to page: **P101**

产品清单所在页面

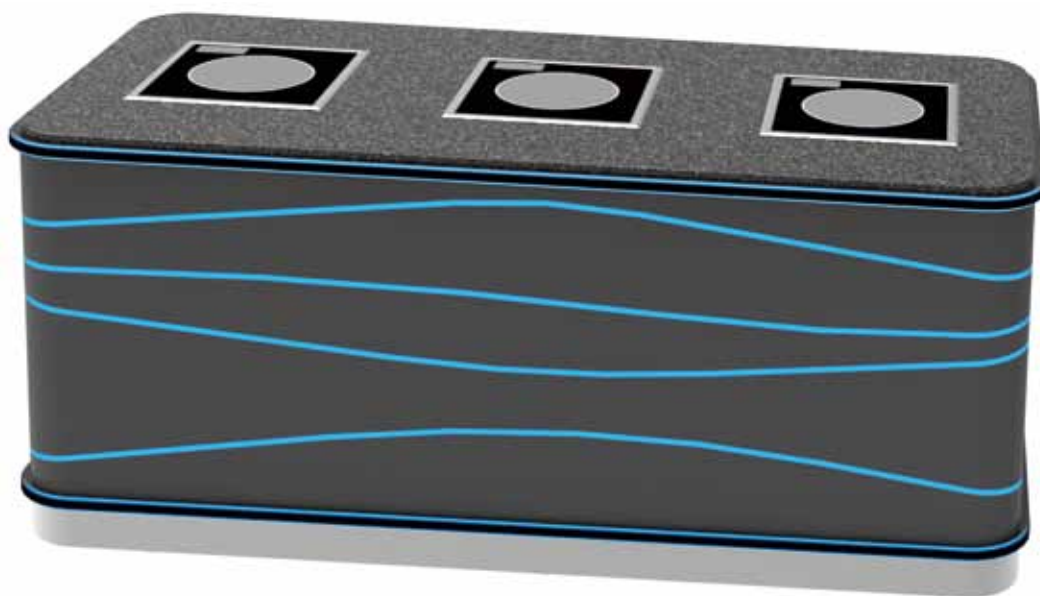

We create this to match with the Fashion Tai-Ji series. The wave line LED beautify the buffet station. The colorful LED collision-resistant design can not only decorate the buffet station, but also protect it well.

与太极系列相匹配。波浪状的灯光装饰，美化了布菲车的外观。采用七彩防撞灯边，更好地保护布菲车。

Color For Surface Material
表面材质选项

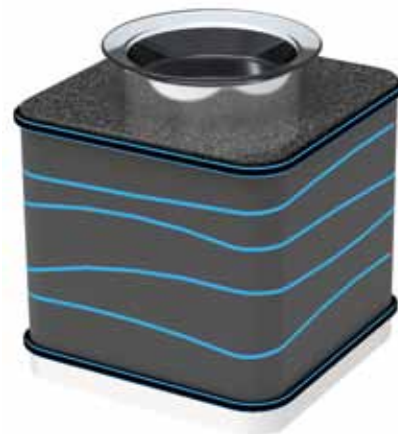
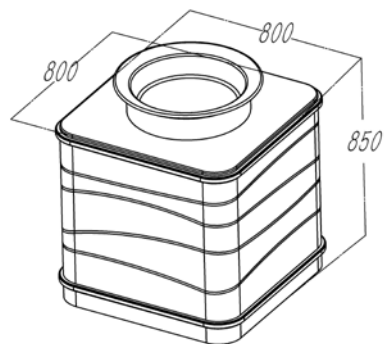
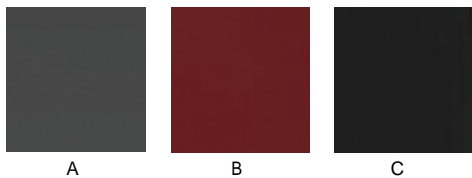

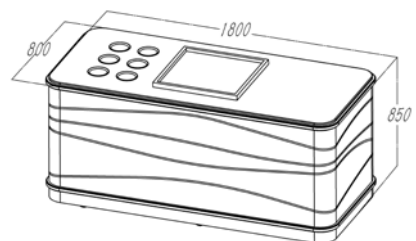
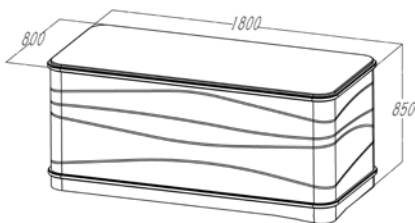
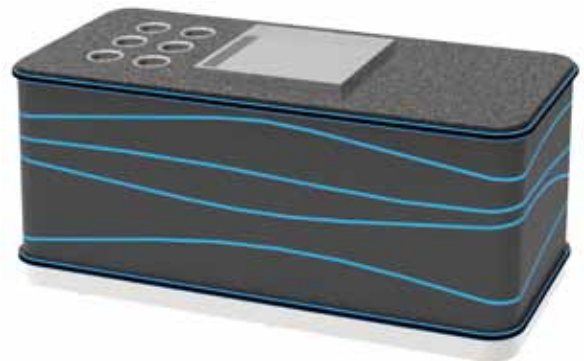
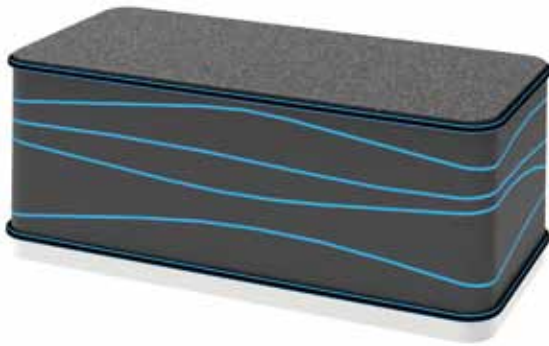
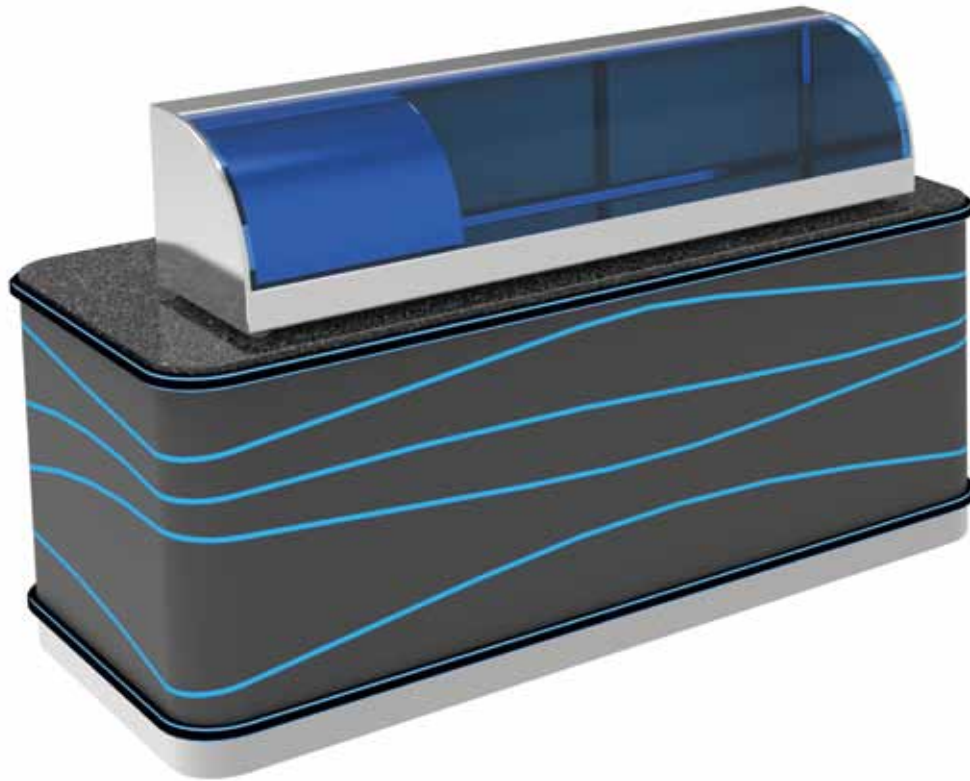

SCC.A-JF 欧典系列

European Classical Series

Product list to page: **P102**

产品清单所在页面



Wooden structure with colorful LED system, hollow-out reticulated pattern on both sides. The centre stainless steel pattern can be replaced by the hotel logo, which looks more noble.

整体木结构，带 LED 灯，旁边带镂空不锈钢花纹。中间不锈钢花纹可换酒店 logo，更显高贵。



Color For Surface Material
表面材质选项

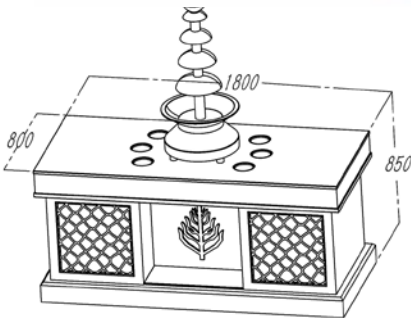
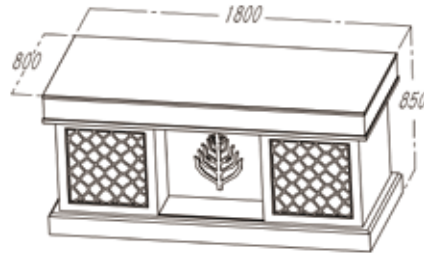
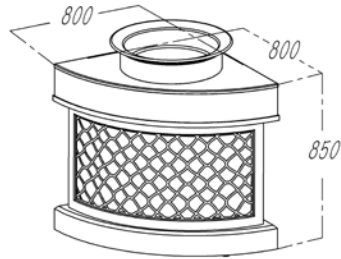
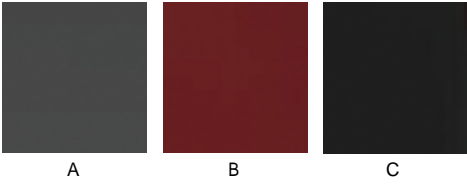

SCC.A-JG 商务（木纹）系列 *Commerce (wood grain) Series*

Product list to page: **P103-104**

产品清单所在页面

Wood structure, concise style. Varians (Fan-shaped, cambered shape and retanglnlar shape). shape for your choice, which can be flexibly assembled into wave, circle and straight line.



全木质结构，简约外形尺寸，分扇形和长方形外形，可组合波浪、圆形等多种组合结构。

Color For Wood Grain
台面木纹选项



A

B

C





SCC.A-JG112



SCC.A-JJ127

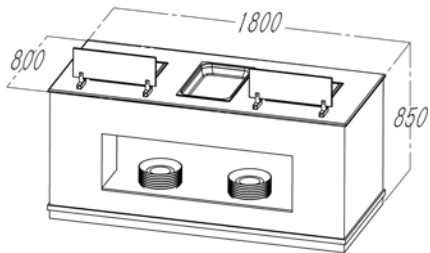

A:
standard
标准台

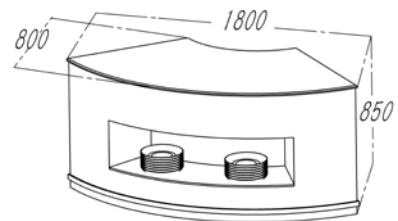

B:
fan-shaped station
扇形台

SCC.A-JH 网络智能系列

Cyber Intelligent Series

Product list to page: **P105**

产品清单所在页面



All-metal construction. with colorful LED line collision-resistant edge. The appearance of this buffet station looks more, outstanding for its front diagonally edge, with the table PC ,the buffet station become more intelligent.

全金属材质打造，使用七彩防撞灯边。顶端采用斜口设计，外观更架突出。配件平板电脑，智能科技。



Color For Marble
台面大理石选项



A

B

C

Color For Surface Material
表面材质选项



D

E

F

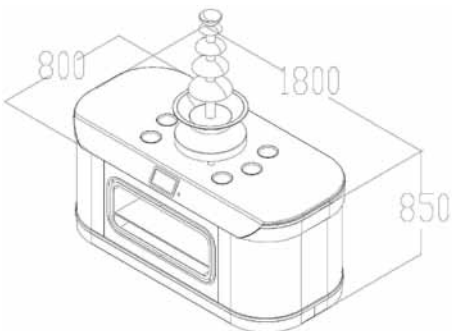
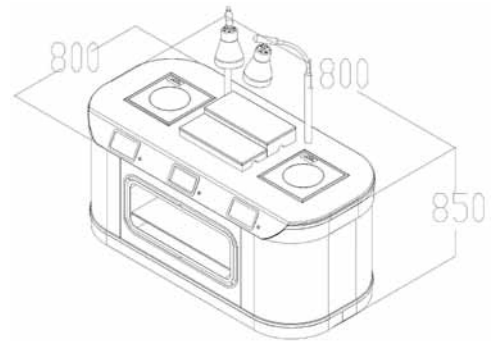
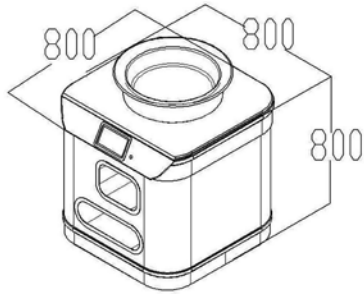

Product list to page: **P106**

产品清单所在页面

Metal structure, all around is arc-shaped design, with the anti-collision colorful LED belt, nice-looking and utilitarian.

全金属材质打造，四边采用弧形设计。使用七彩防撞灯边。美观实用。



Color For Wood Grain
台面木纹选项

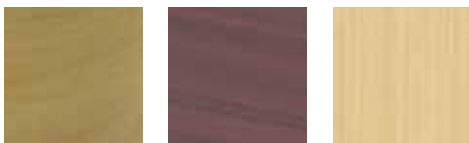

A

B

C

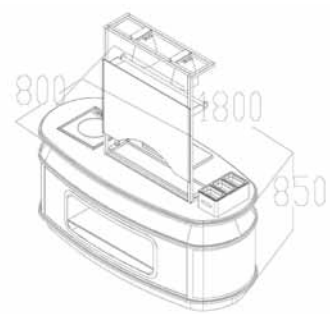
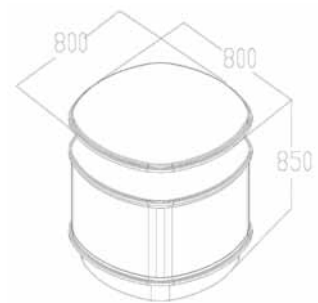
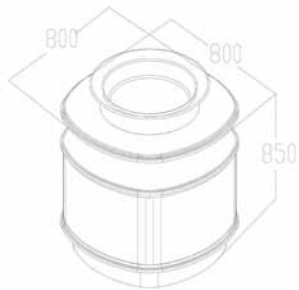

SCC.A-JJ 轻质纤维系列

Light Fiber Series

Product list to page: **P107-108**

产品清单所在页面



Color For Surface Material
表面材质选项

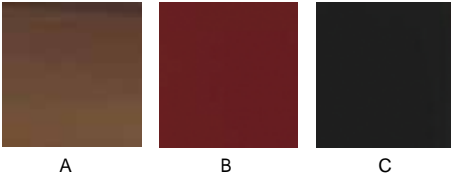

Light fiber-glass material, reduce the weight of the buffet station. Arc-shaped design, nice looking, middle is LED light. Hollow pattern could be chosen.

采用轻质纤维材料，减轻布菲车的重量。弧形造型，美化外观。中间带 LED 发光，可增加镂空不锈钢图案。

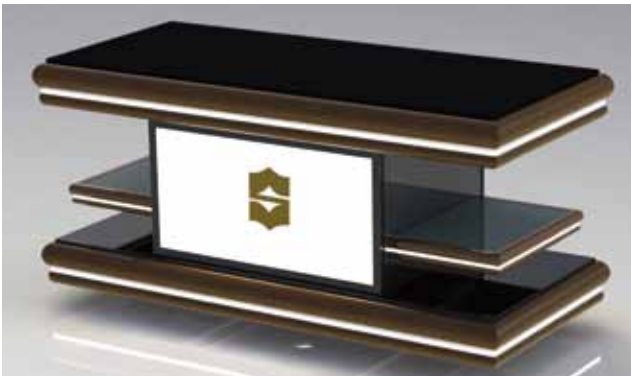

SCC.A-JJ111

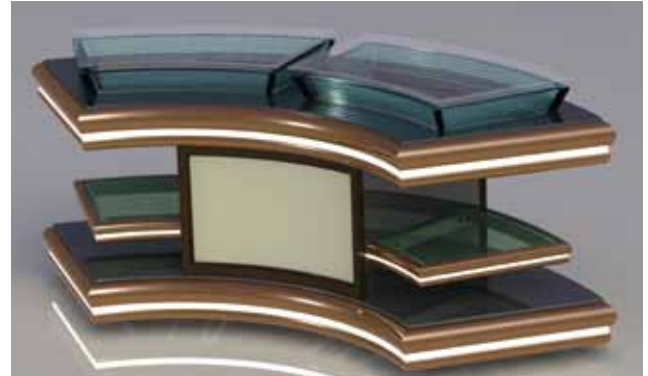

SCC.A-JJ117

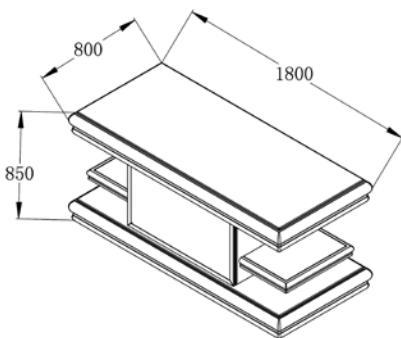

A:
standard station
标准台

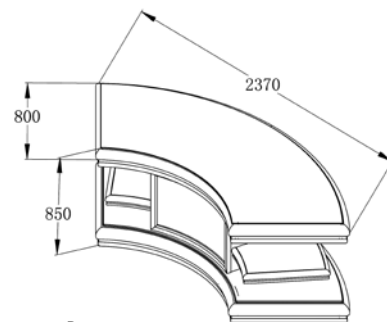

B:
fanshape station
扇形台

SCC.A-JK 椭圆系列

Oval Shape Series

Product list to page: **P109**

产品清单所在页面

Color For Wood Grain

台面木纹选项



A

B

C

The whole series is oval shaped design, with the anti-collision colorfull LED belt and veneer wood material.

整体为椭圆外观设计。装饰木饰材质带有七彩防撞灯边。



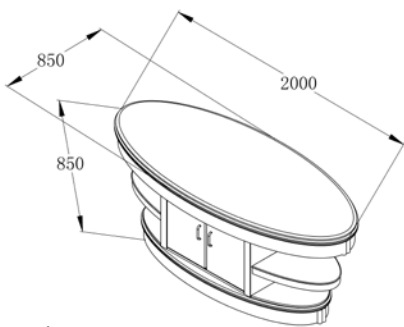
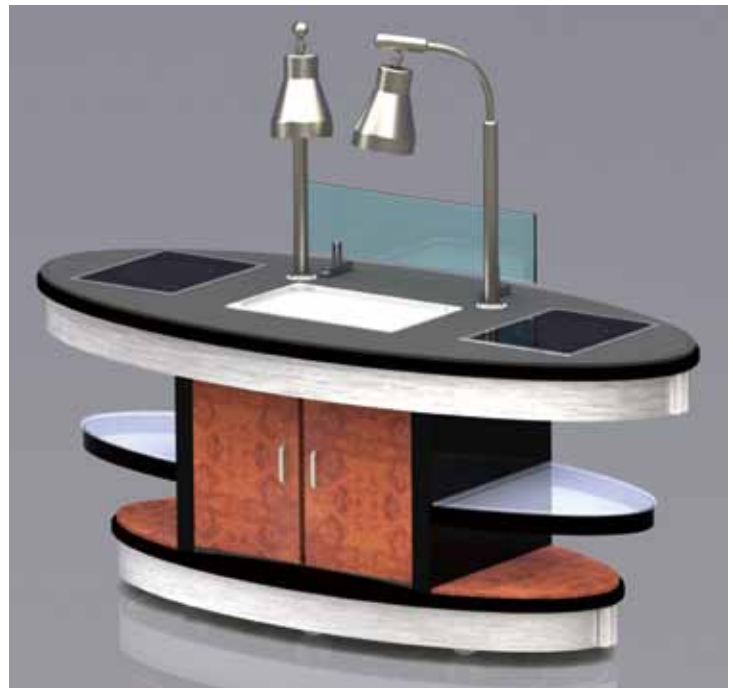

A:
standard station
标准台

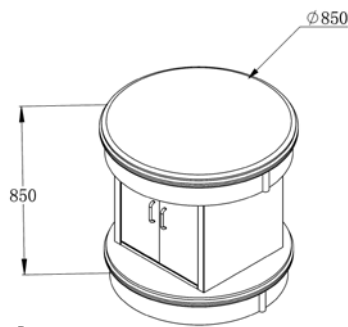

B:
side station
附台

SCC.A-JL 全实木系列

Solid Wood Series

Product list to page: **P110**

产品清单所在页面

Color For Wood Grain
台面木纹选项



A

B

C

Solid wood structure, steady and strong. Featured by simple design style. Outstanding the wood grain. With nostalgia feeling in the modern commercial purposes.

全木组成，稳重厚实。简约外观设计，充分突出木纹的效果。
在现代商务功能中又带有浓厚的怀旧情调。



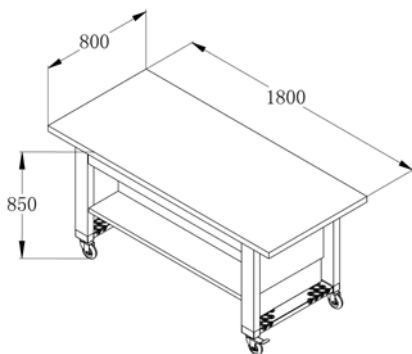

A:
standard station
标准台



B:
Combined table
组合台

SCC.A-JM 经典木艺系列

Classical Wooden Art Series

Product list to page: **P111-112**

产品清单所在页面

Color For Wood Grain
台面木纹选项



A

B

C

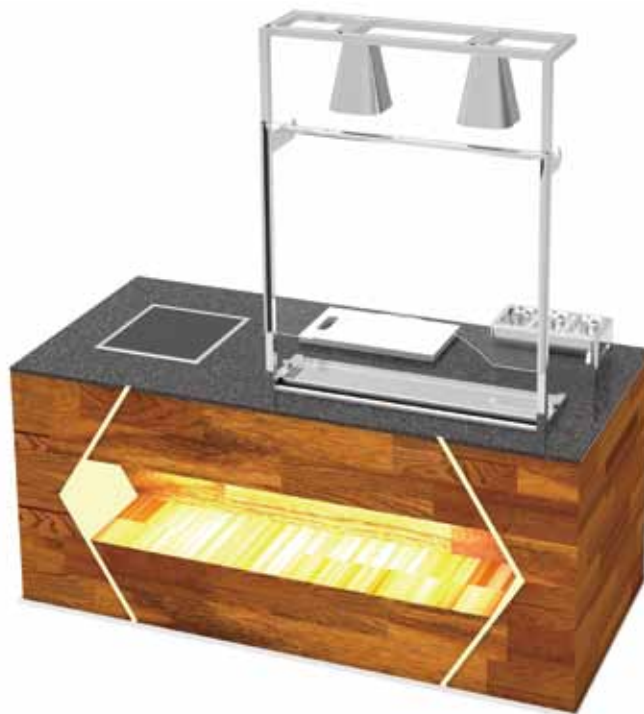

Wooden struture, surface is irregular batten, rough wood grain pattern display the nature effect much more.



木质结构，表面分为各个不规则长度木条。
不同粗犷木纹组合，更架突出大自然效果。



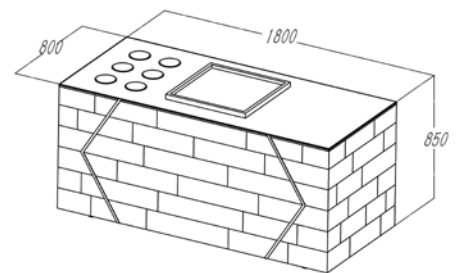
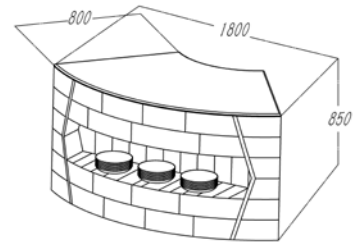
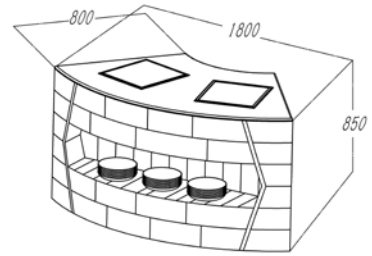
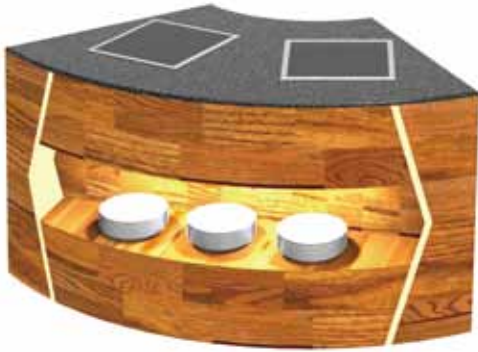

SCC.A-JN 弯钢系列

Curve Metal Series

Product list to page: **P113-114**

产品清单所在页面



Sted strutture, reciprocal chiasma curve tube as the middle supporting parts, Two side hot-melt glass show the distinctive style.

采用不锈钢结构，相互交错的弯管组成中间支撑零件。两侧悬空热熔玻璃，形成鲜明风格。

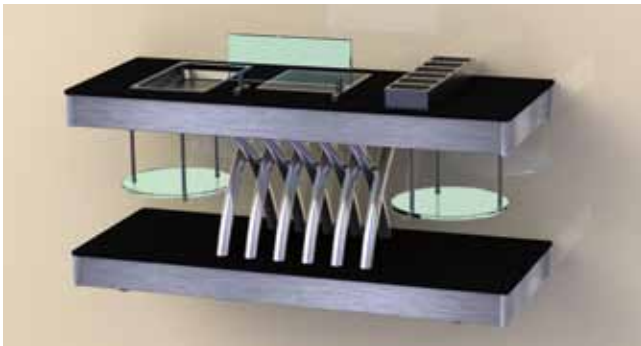
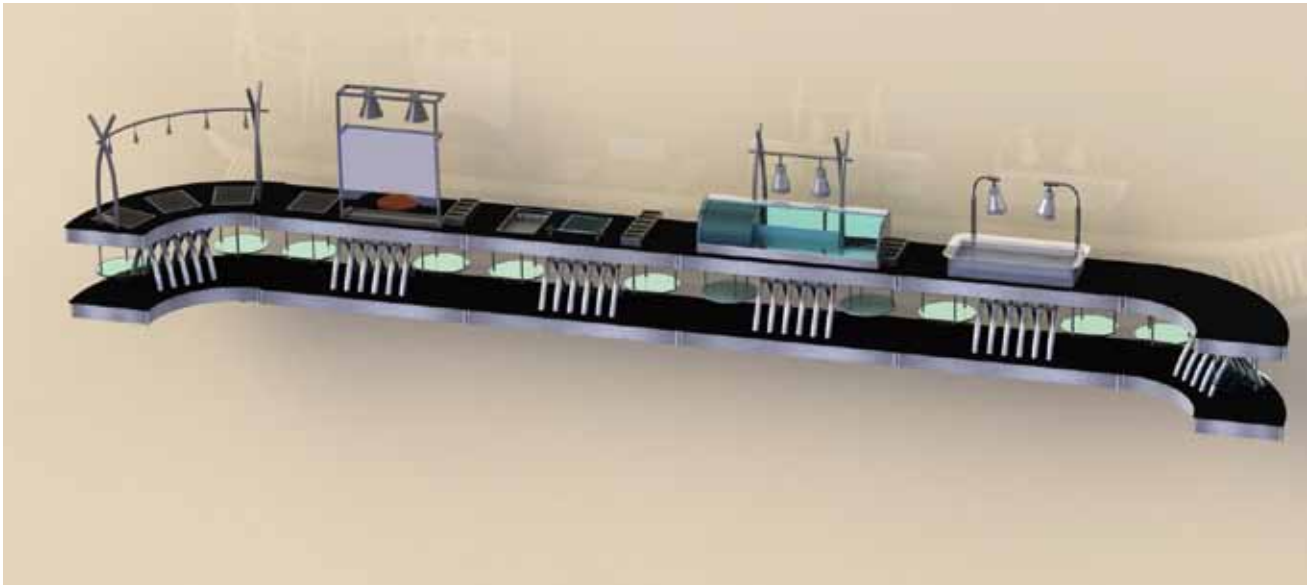

SCC.A-JN112

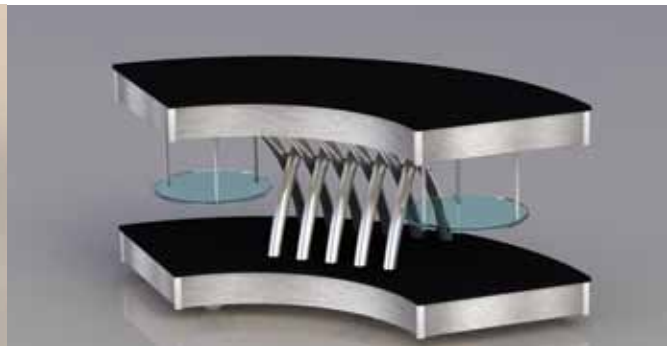

SCC.A-JN127

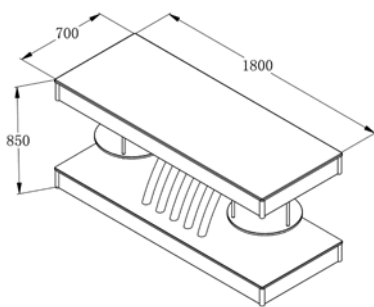

A:
standard station
标准台

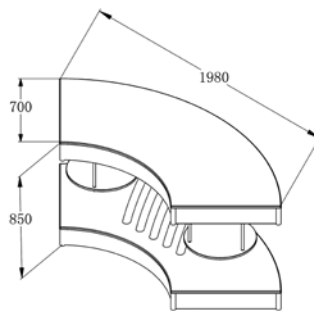

B:
fanshape station
扇形台

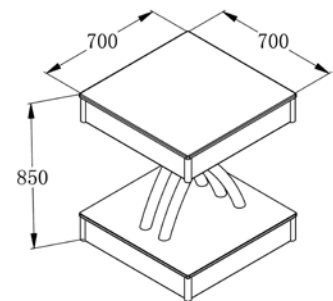

C:
side station
附台

SCC.A-J0 直钢系列

Vertical Metal Series

Product list to page: **P115-116**

产品清单所在页面

Double-deck design, wooden cabinet and circular tube as the support parts, Two side is suspended hot-melt glass, steel and wood upgrade the outlooking of the Buffet station, show the different style.

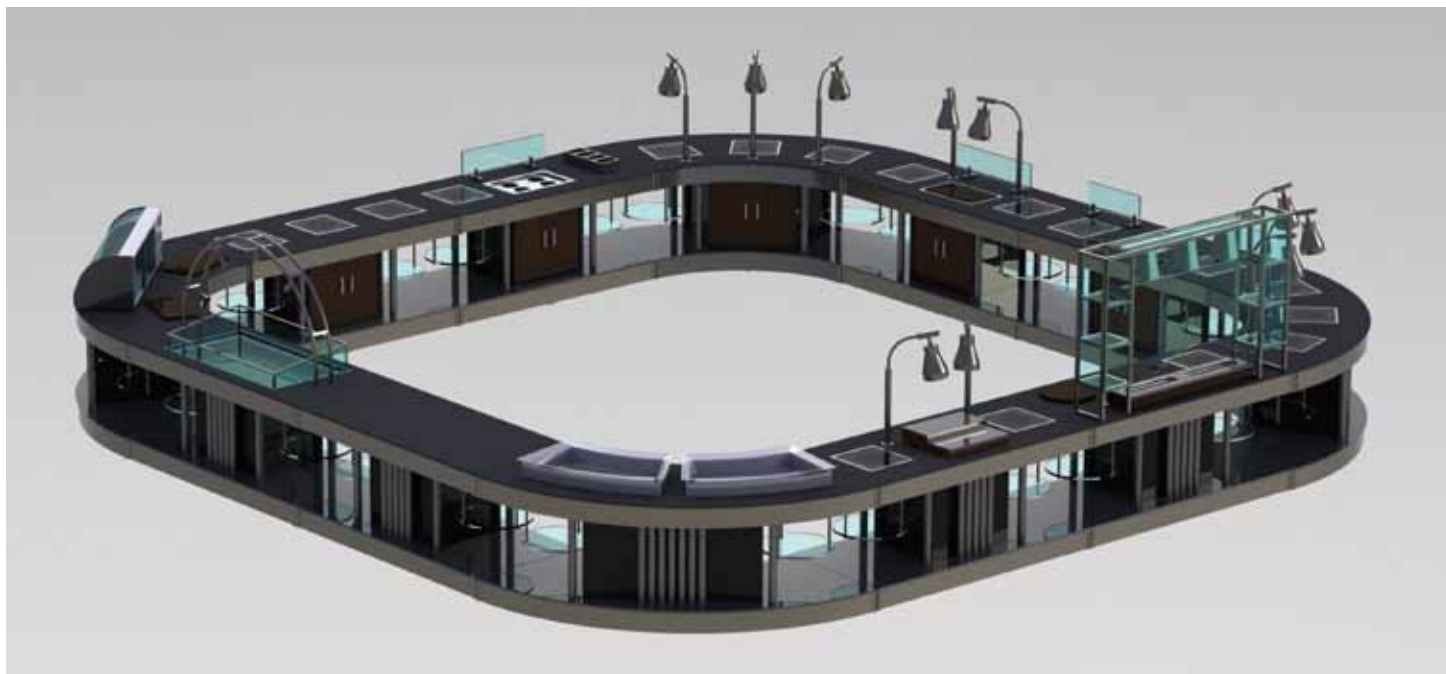

采用双层设计，中间用木盒和圆管支撑。两侧的热熔玻璃采用悬挂设计。不锈钢与木盒的结合，丰富了布菲车的外观，带出不一样的风格。

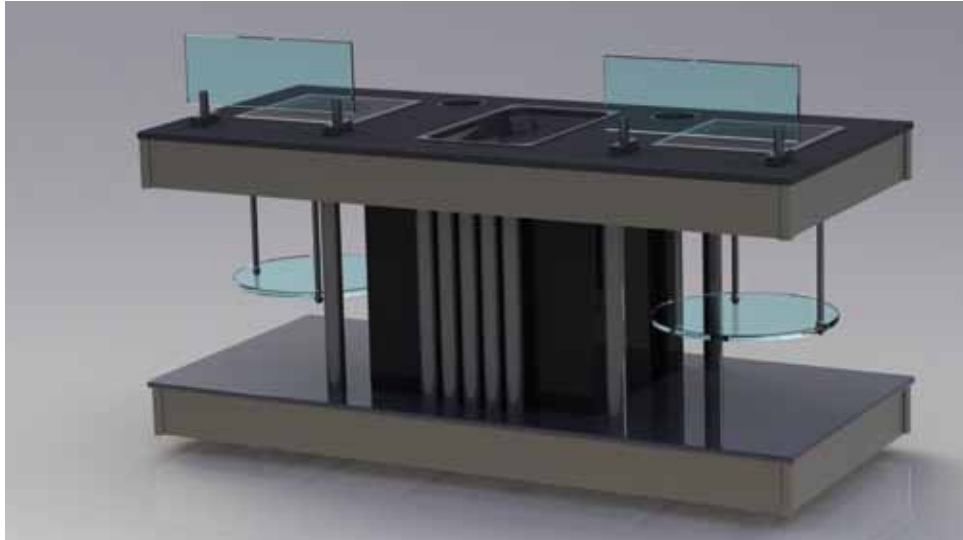

SCC.A-J0112

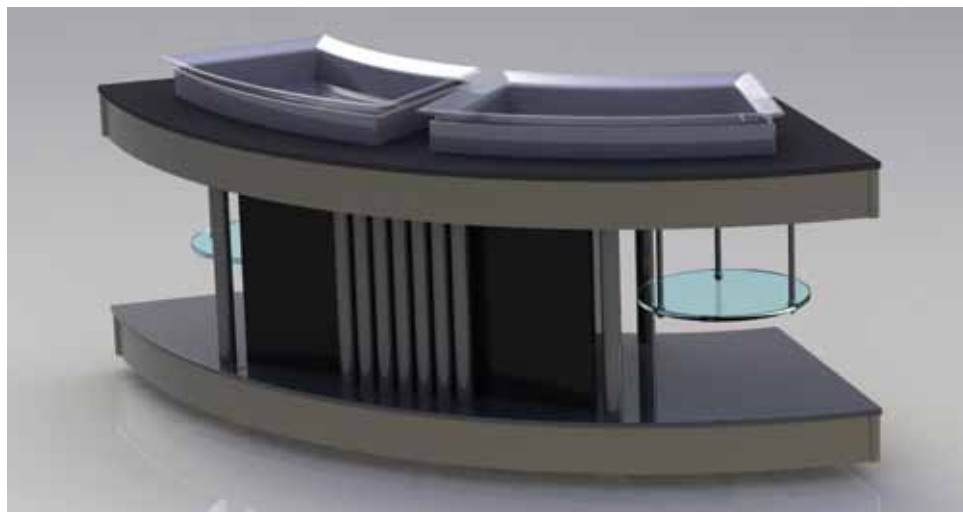

SCC.A-J0127

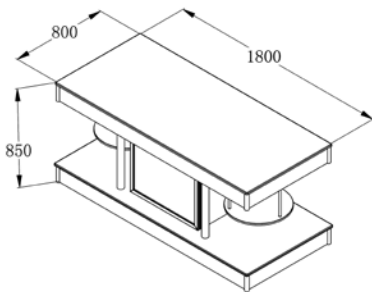

A:
standard station
标准台

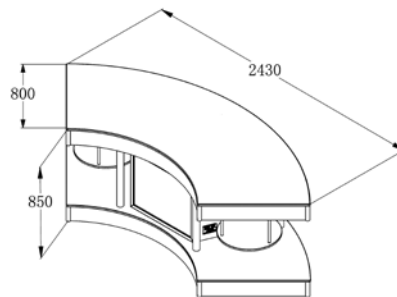

B:
fanshape station
扇形台

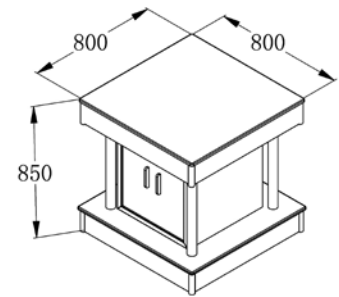

C:
side station
附台

Product list to page: **P117**

产品清单所在页面

Using malposed stack-up desing with arc-shaped appearance. All stainless steel design with LED decorative rim. The stations can be combined in any ways you like by using malposed stack-up desing.



采用错开层叠设计，弧形的外观。不锈钢表面，层与层之间增加 LED 灯。由于错开设计，布菲车可以随意组合。

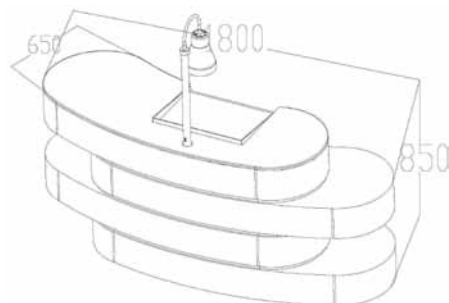
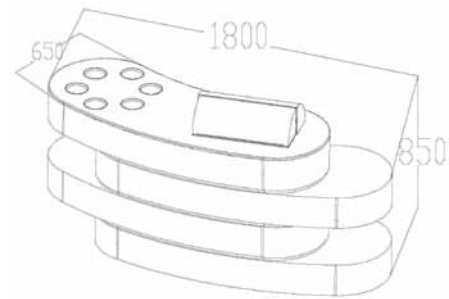
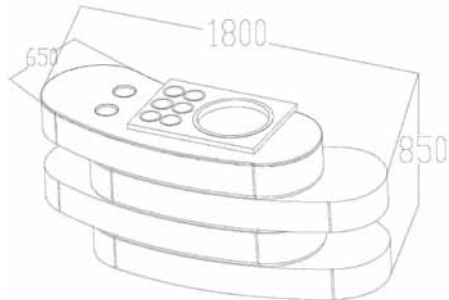
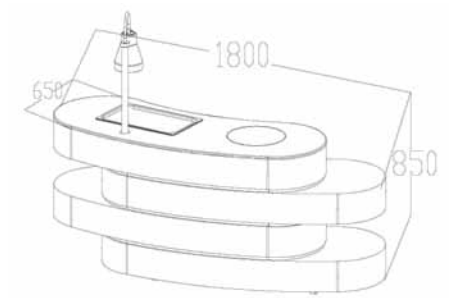

SCC.A-JQ 风尚系列

Prevailing Custom Series

Product list to page: **P118**

产品清单所在页面

Stainless steel structure, hollow-out decorative pattern design with changable LED system.

全不锈钢结构。带镂空花纹图案，带七彩 LED 效果。



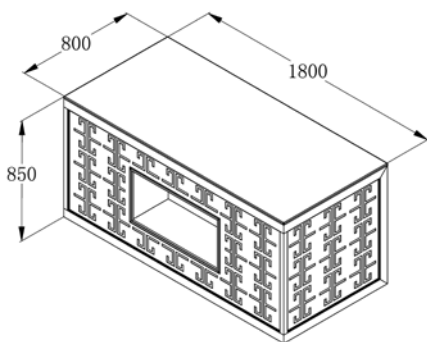

A:
standard
标准台

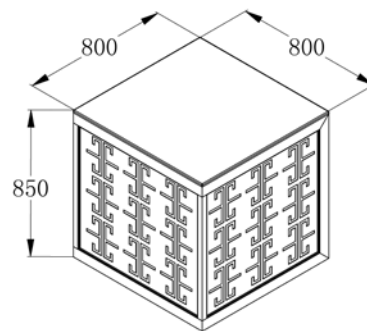

B:
side station
附台

Product list to page: **P119**

产品清单所在页面



Stainless steel and acrylic stack-up body design, the size of stainless steel and acrylic scale down from the bottom, will be more layering, elegant and concise.

采用层叠式设计，往上按比例缩小尺寸。层次感非常强烈。布菲车一半为不锈钢，另一半带LED效果。简洁优雅。

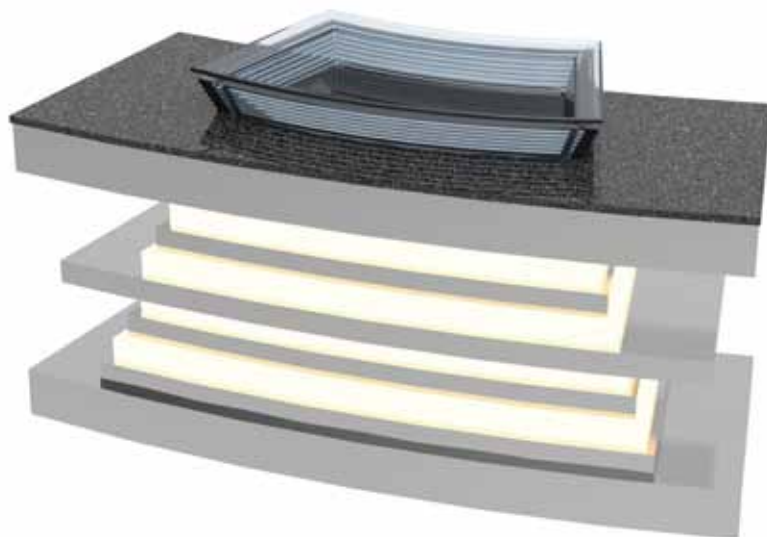

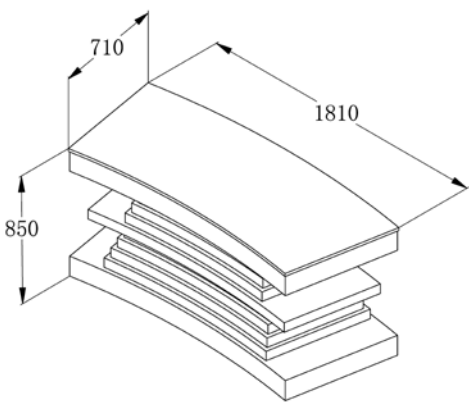
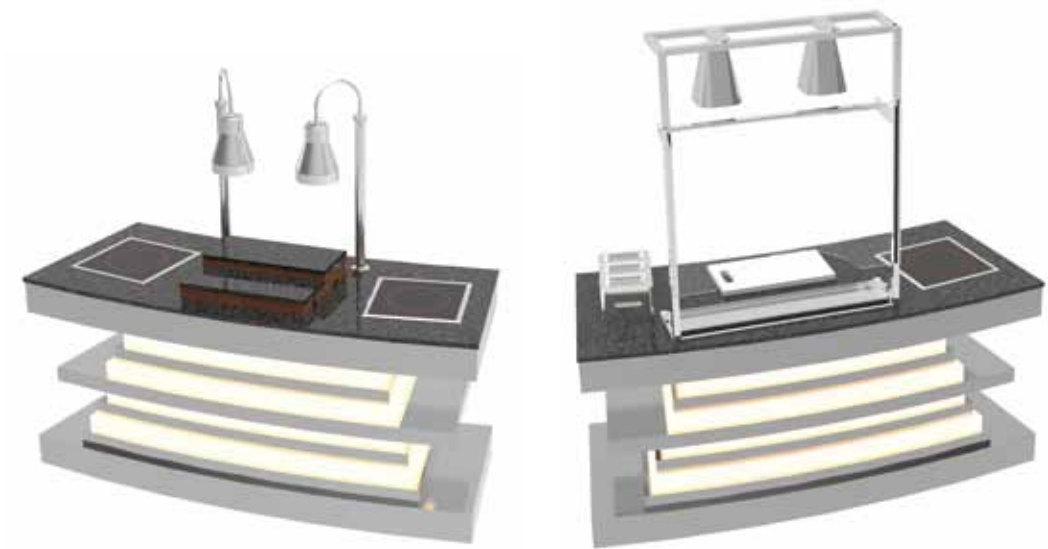
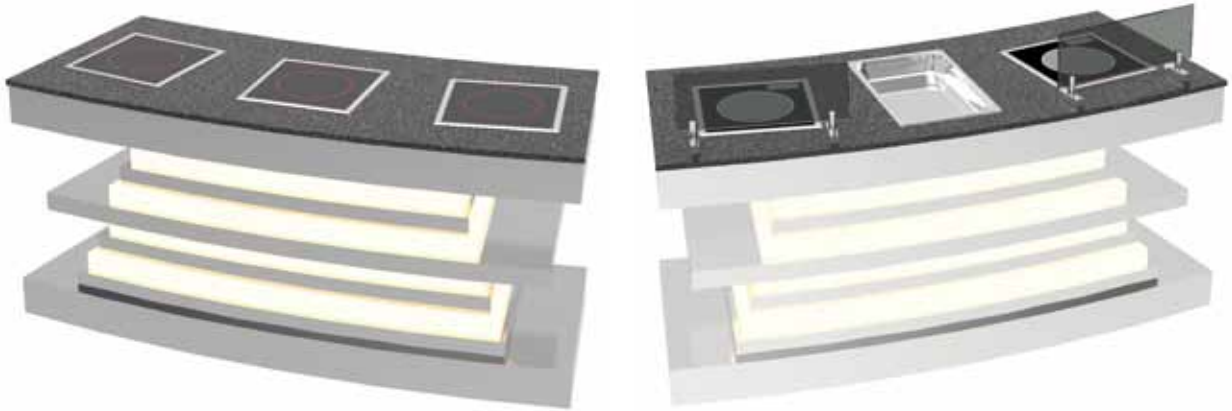

A:
standard station
标准台

Product list to page: **P120**
产品清单所在页面

The whole stainless steel structure with double Rubik's cube, the Rubik's cube is made of stainless steel and LED for more attractive. Hollow-out middle design, increasing the place for plates.

整体为不锈钢结构。采用双魔方外观作为支撑。一半为不锈钢，一半为灯箱，突出魔方的效果。中间镂空，放盘空间增加。



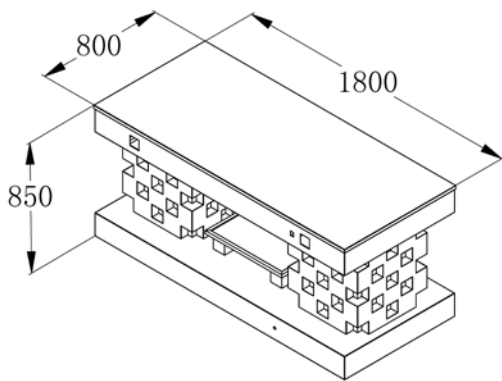
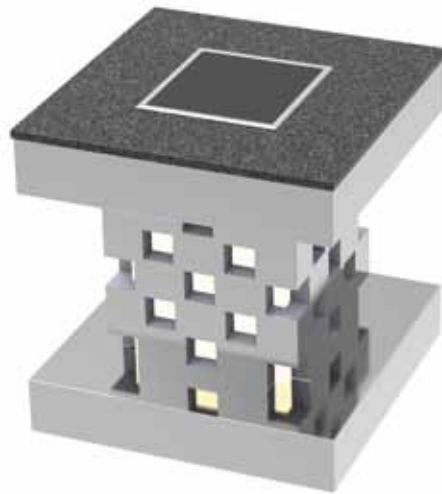

A:
standard station
标准台

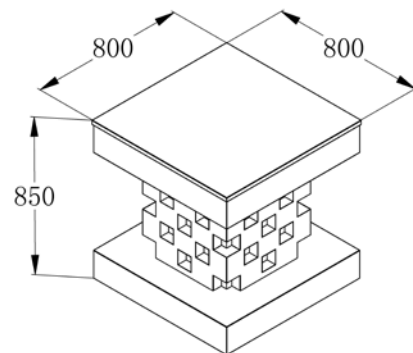

B:
side station
附台

SCC.A-JT 皇室系列

Royal Series

Product list to page: **P121**
产品清单所在页面

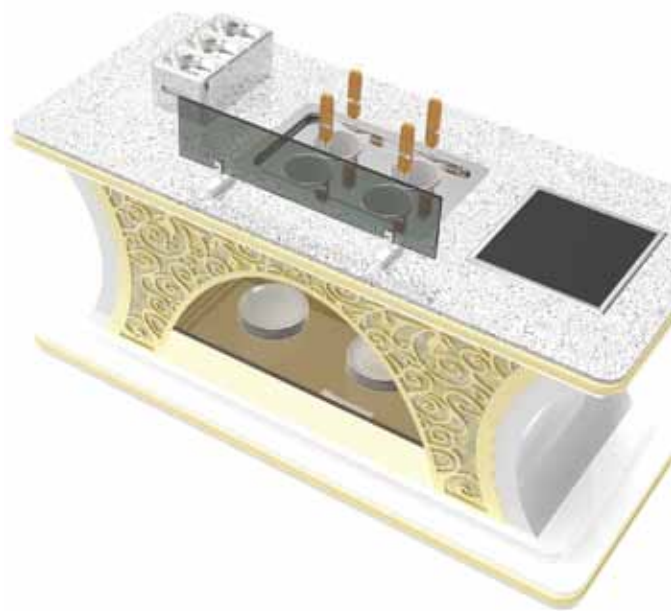

Hollow metal with good plated, intelligent colorful ledlight control, manifest the luxury royal style.

镂空金属镀饰金面，智能LED七彩灯光遥控，彰显奢华皇室风格。

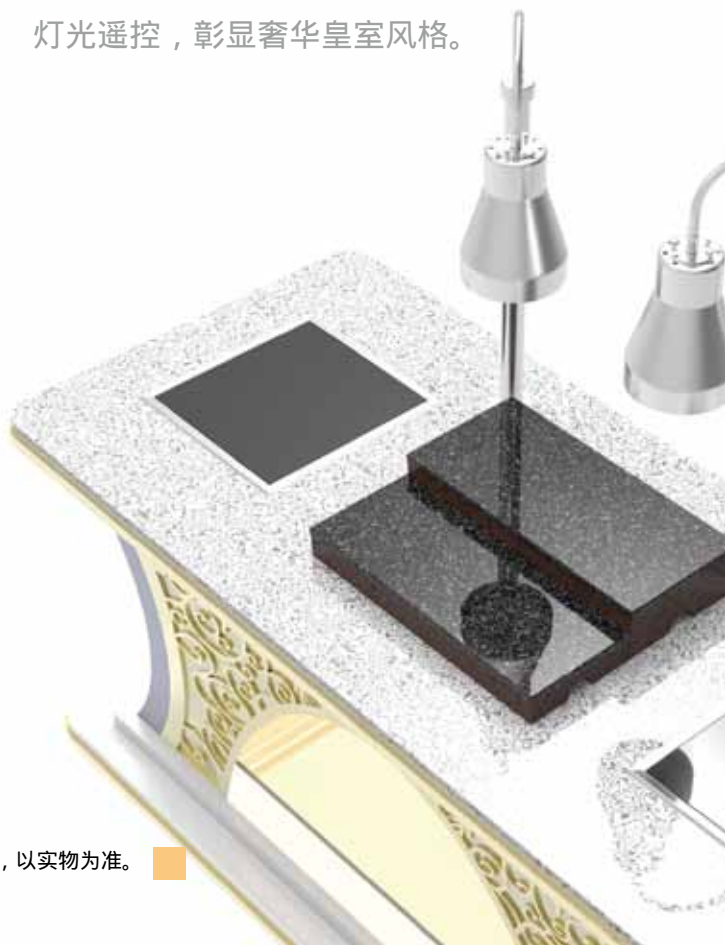

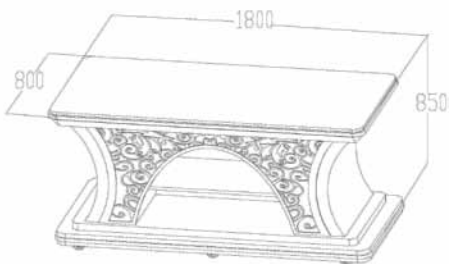
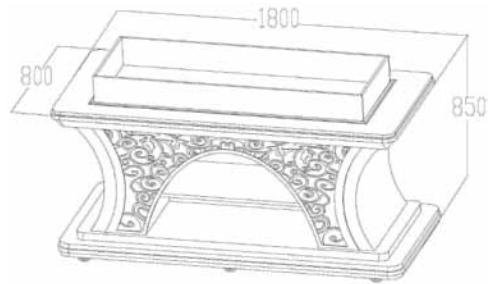
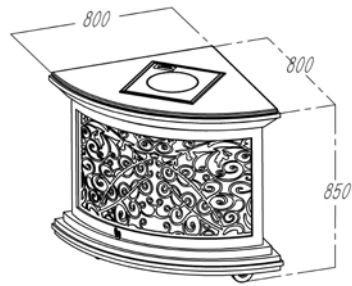

SCC.A-JU 优雅系列

Elegance Series

Product list to page: **P122-123**

产品清单所在页面

Color For Marble
台面大理石选项

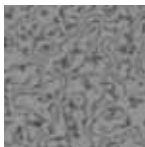

A



B

Color For Surface Material
表面材质选项



A



B

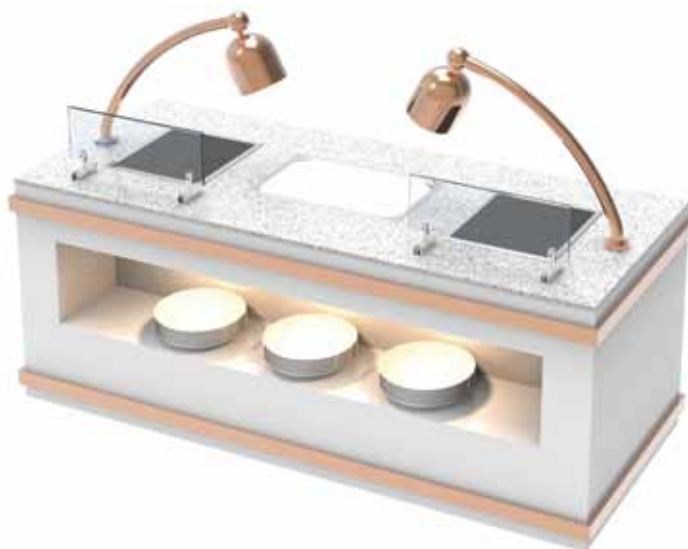
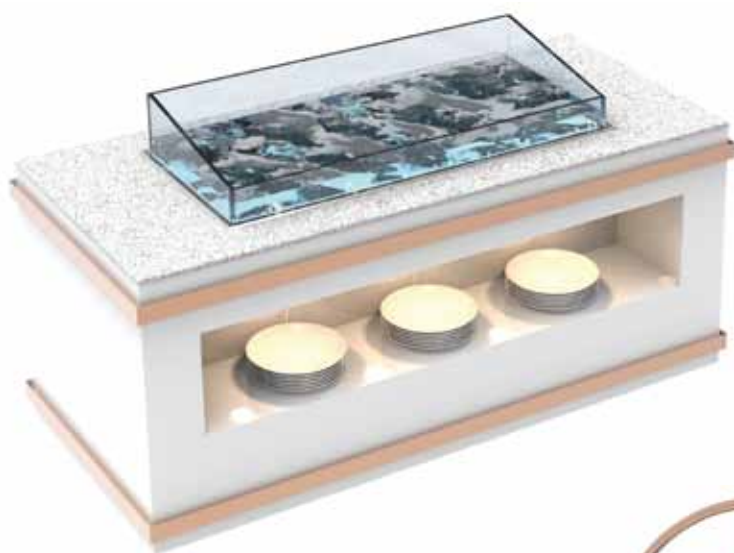

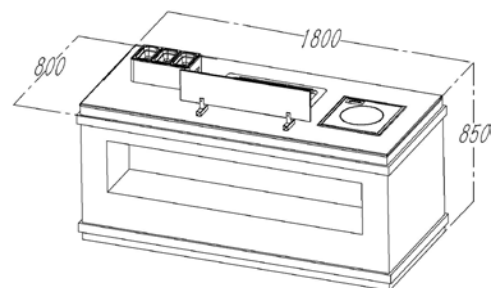
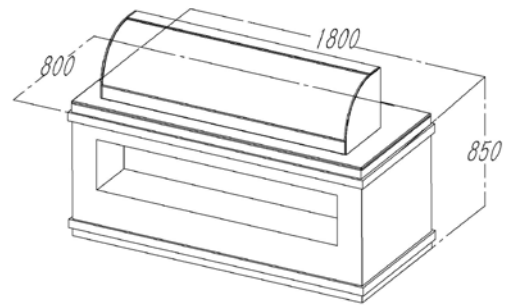
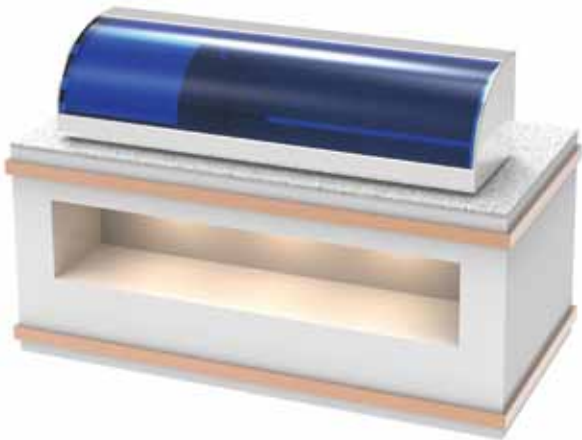
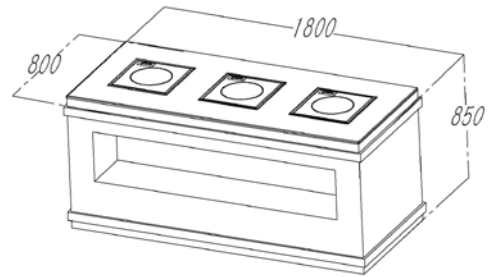
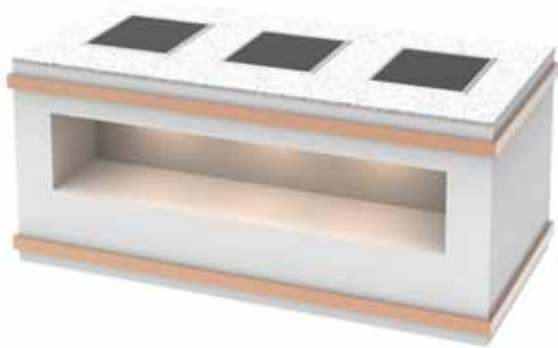





SCC.B-A

茶歇台系列 *Tea break table series*

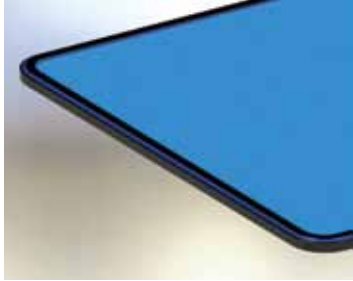

LED edge
塑钢 LED 包边



Steel edge
钢包边





LED edge
塑钢 LED 包边



Steel edge
钢包边



SCC.B-A103 (塑钢 LED 包边)
Size:1500x700x750/950/1150

SCC.B-A104 (钢包边)
Size:1500x700x750/950/1150

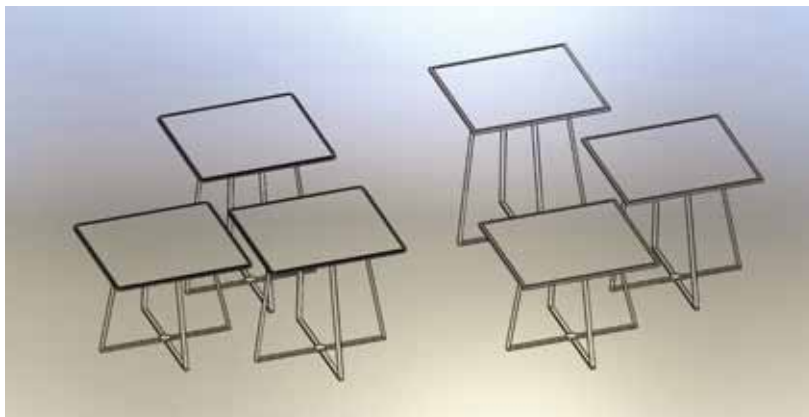

SCC.B-A105 (塑钢 LED 包边)
Size:1500x700x750/950/1150

SCC.B-A106 (钢包边)
Size:1500x700x750/950/1150

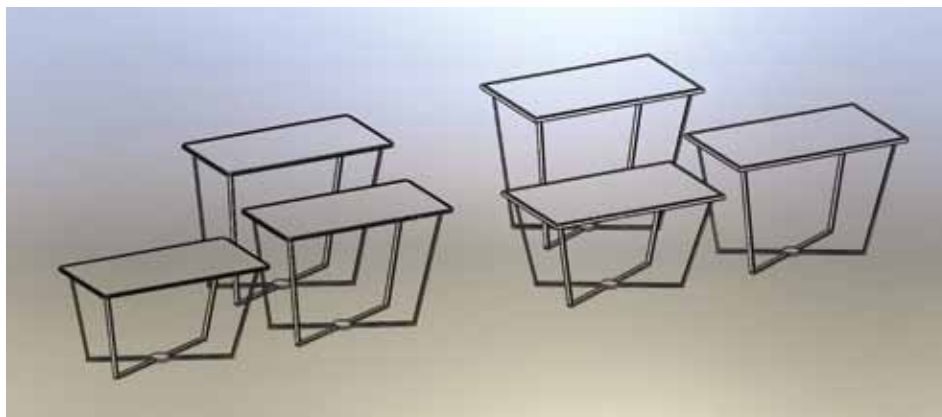

SCC.B-A101 (塑钢 LED 包边)
Size:1500x700x750/950/1150

SCC.B-A102 (钢包边)
Size:1500x700x750/950/1150

SCC.B-B

茶歇台系列 *Tea break table series*

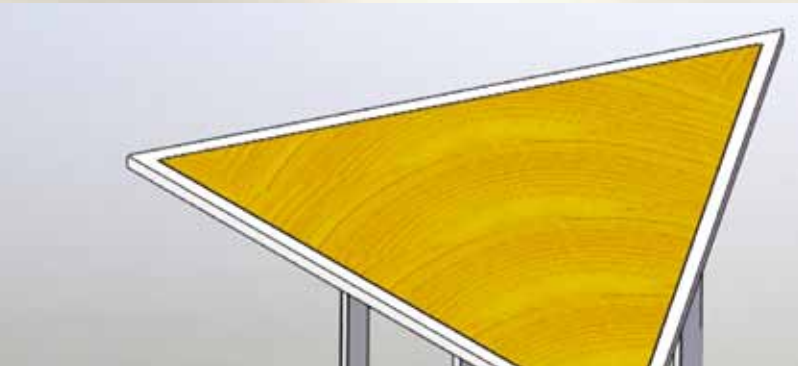
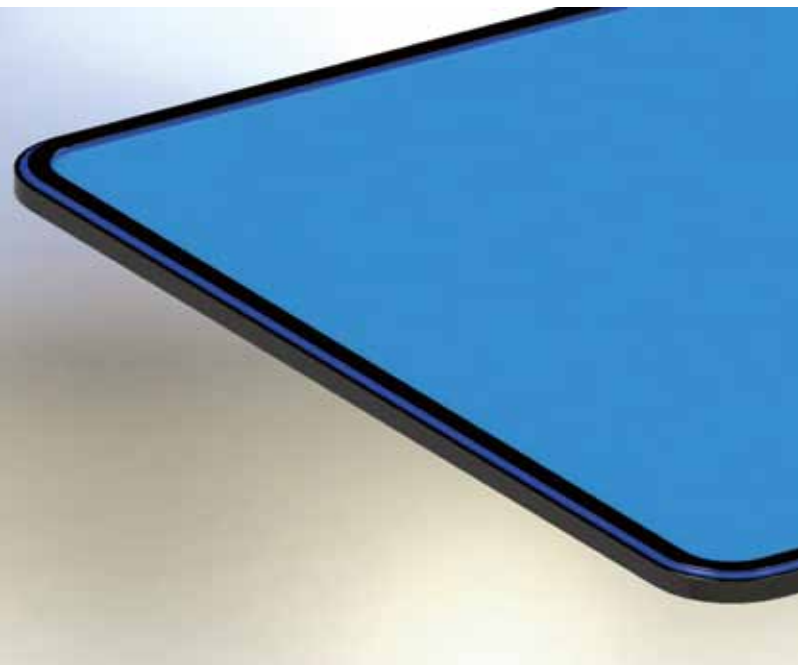

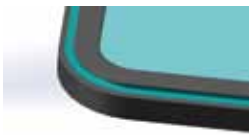

LED edge
塑钢 LED 包边



SCC.B-B101 (塑钢 LED 包边)
Size:800x750/950/1150



Steel edge
钢包边



SCC.B-B102 (钢包边)
Size:800x750/950/1150



SCC.B-B103 (塑钢 LED 包边)
Size:800x800x750/950/1150

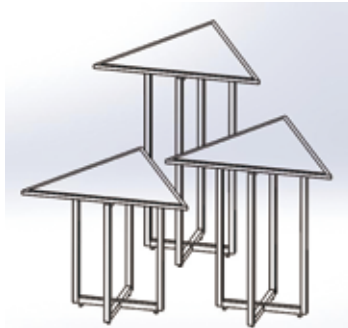

SCC.B-B104 (钢包边)
Size:800x800x750/950/1150

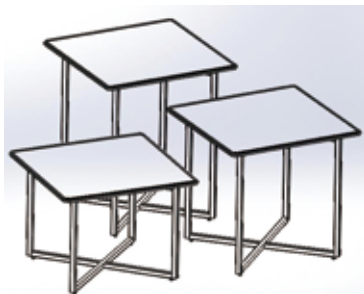

SCC.B-B105 (塑钢 LED 包边)
Size:1000x1000x750/950/1150

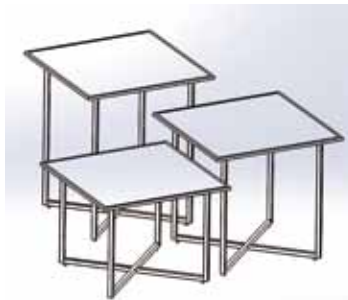

SCC.B-B106 (钢包边)
Size:1000x1000x750/950/1150

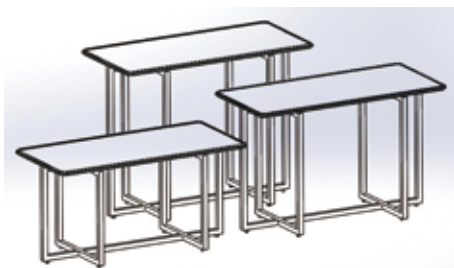

SCC.B-B107 (塑钢 LED 包边)
Size:1500x700x750/950/1150

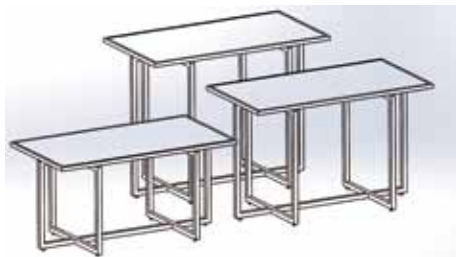

SCC.B-B108 (钢包边)
Size:1500x700x750/950/1150



SCC.B-B109 (塑钢 LED 包边)
Size:1500x700x750/950/1150

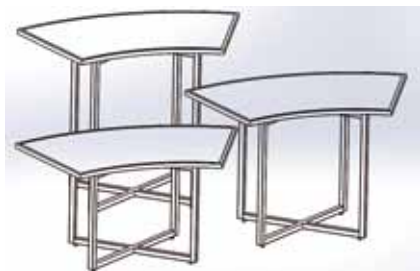

SCC.B-B110 (钢包边)
Size:1500x700x750/950/1150

SCC.B-C

茶歇台系列
Tea break table series



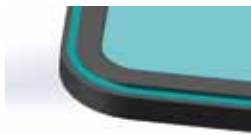

LED edge
塑钢 LED 包边



Steel edge
钢包边

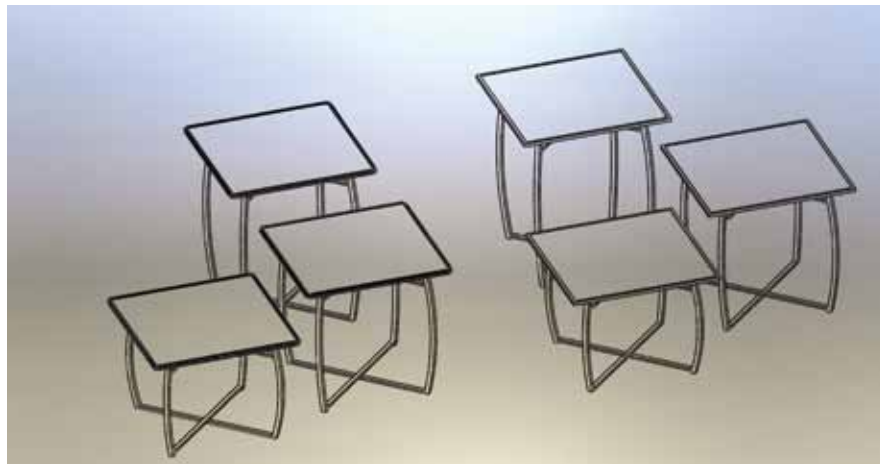

SCC.B-C101 (塑钢 LED 包边)
Size:1000x1000x750/950/1150

SCC.B-C102 (钢包边)
Size:1000x1000x750/950/1150



SCC.B-C103 (塑钢 LED 包边)
Size:800x750/950/1150

SCC.B-C104 (钢包边)
Size:800x750/950/1150

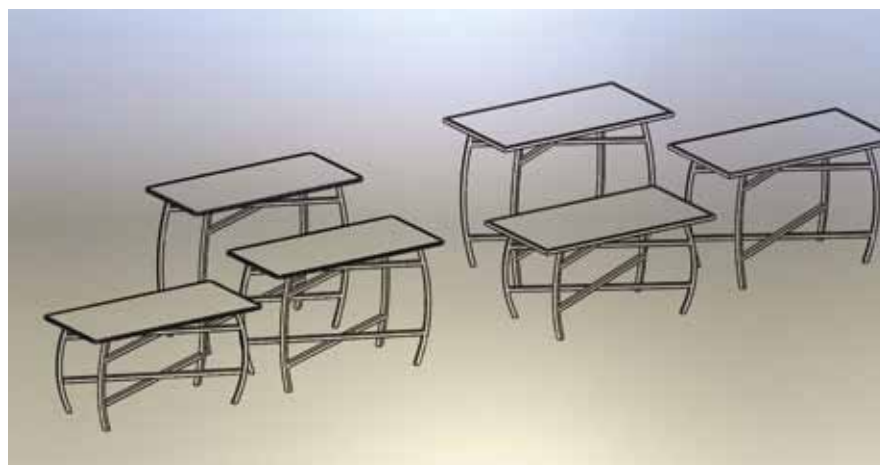

SCC.B-C105 (塑钢 LED 包边)
Size:1500x700x750/950/1150

SCC.B-C106 (钢包边)
Size:1500x700x750/950/1150

SCC.B-D 茶歇台系列
Tea break table series





LED edge
塑钢 LED 包边



Steel edge
钢包边

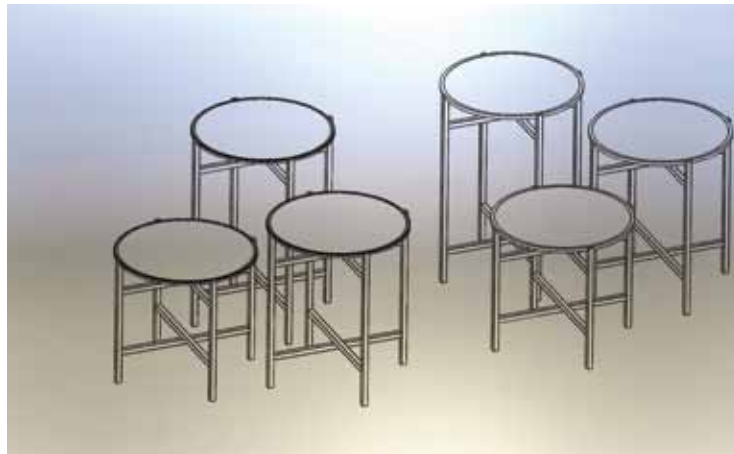

SCC.B-D101 (塑钢 LED 包边)
Size:800x750/950/1150

SCC.B-D102 (钢包边)
Size:800x750/950/1150

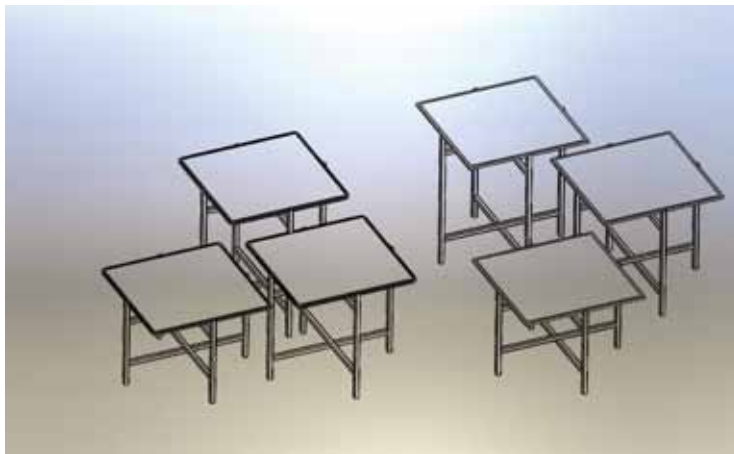

SCC.B-D103 (塑钢 LED 包边)
Size:1000x1000x750/950/1150

SCC.B-D104 (钢包边)
Size:1000x1000x750/950/1150

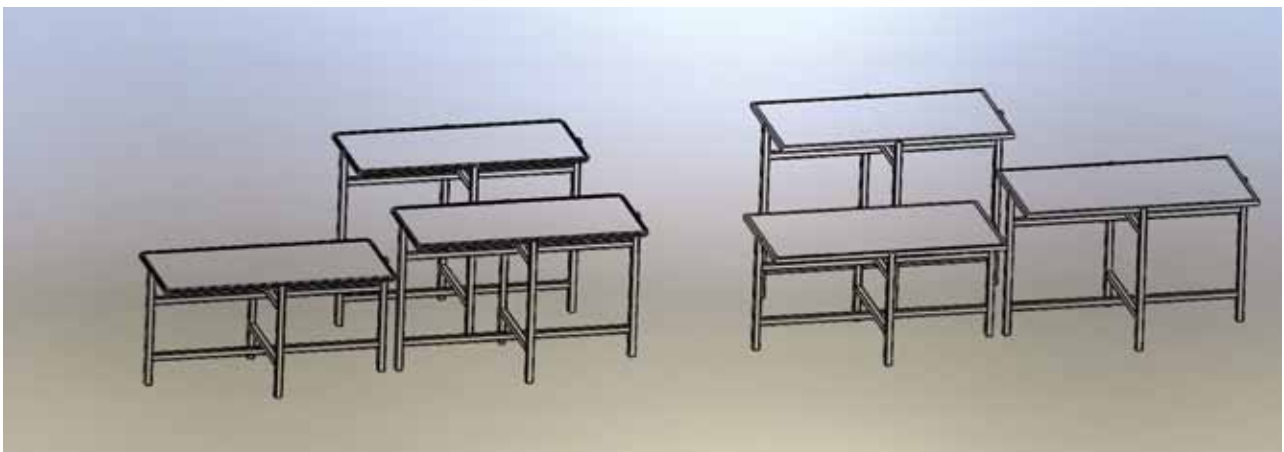

SCC.B-D105 (塑钢 LED 包边)
Size:1500x700x750/950/1150

SCC.B-D106 (钢包边)
Size:1500x700x750/950/1150

SCC.B-E

茶歇台系列 *Tea break table series*

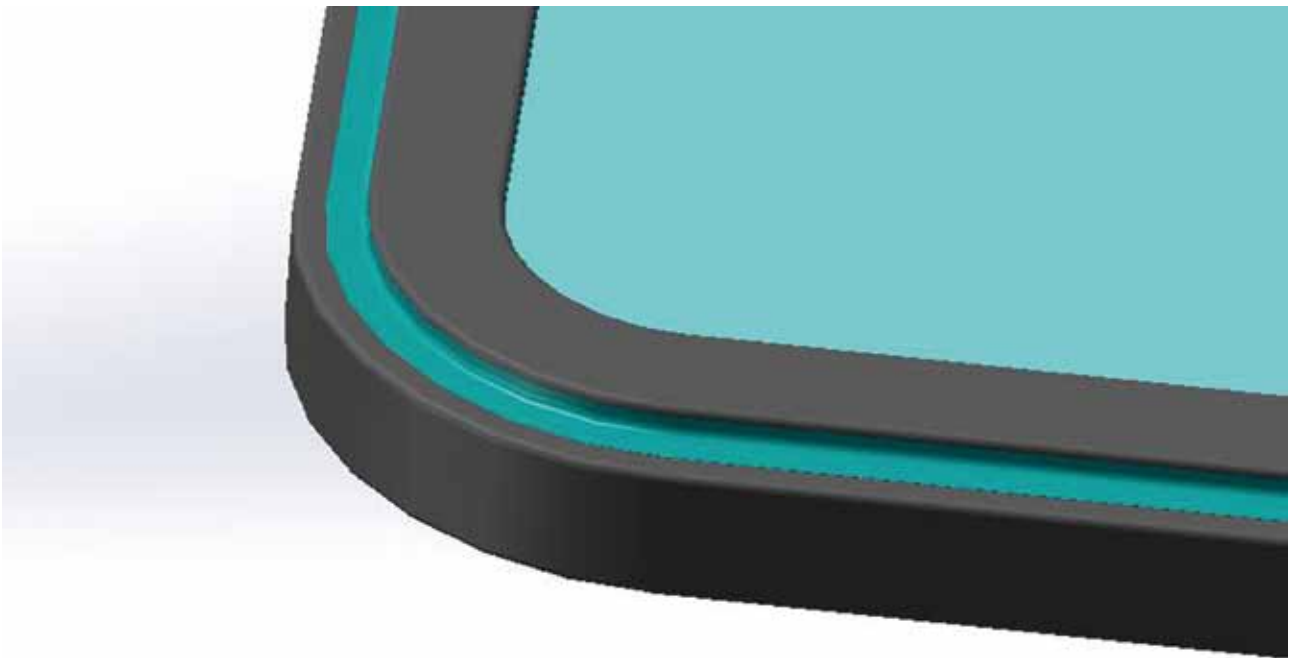

SCC.B-E108
Size:1200x800x1500



SCC.B-E107
Size:1200x1000x800



SCC.B-E109
Size:1200x800x1500



LED edge
塑钢 LED 包边



Steel edge
钢包边



SCC.B-E101 (塑钢 LED 包边)
Size:800x750/950/1150

SCC.B-E102 (钢包边)
Size:800x750/950/1150

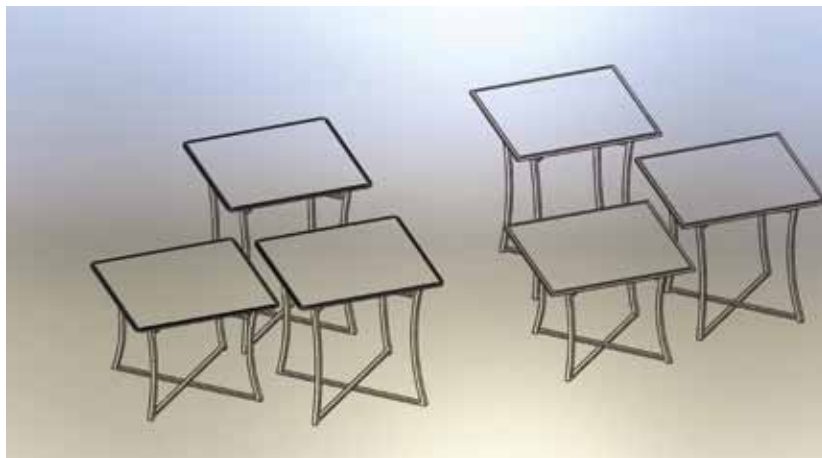

SCC.B-E103 (塑钢 LED 包边)
Size:1000x1000x750/950/1150

SCC.B-E104 (钢包边)
Size:1000x1000x750/950/1150

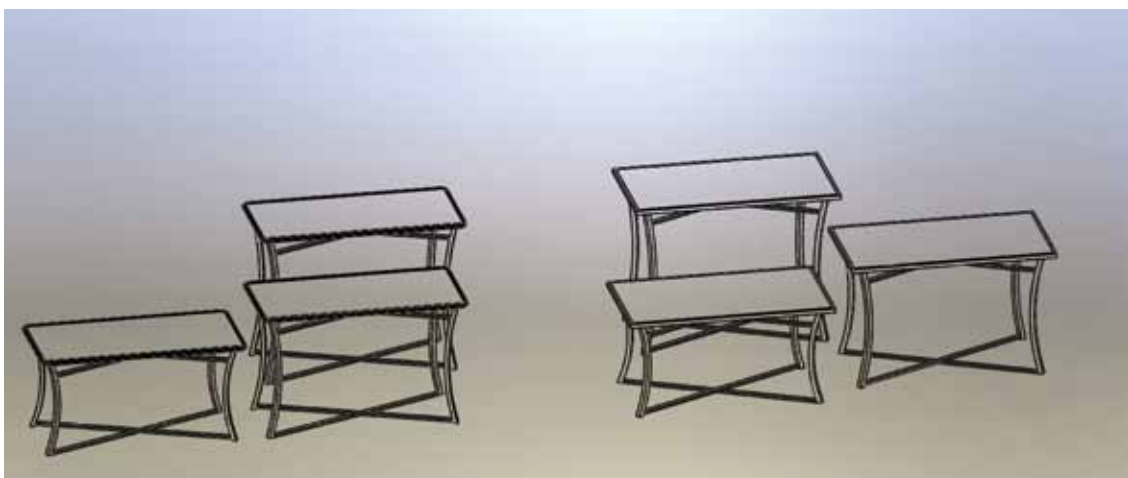

SCC.B-E105 (塑钢 LED 包边)
Size:1500x700x750/950/1150

SCC.B-E106 (钢包边)
Size:1500x700x750/950/1150

SCC.B-F

茶歇台系列
Tea break table series

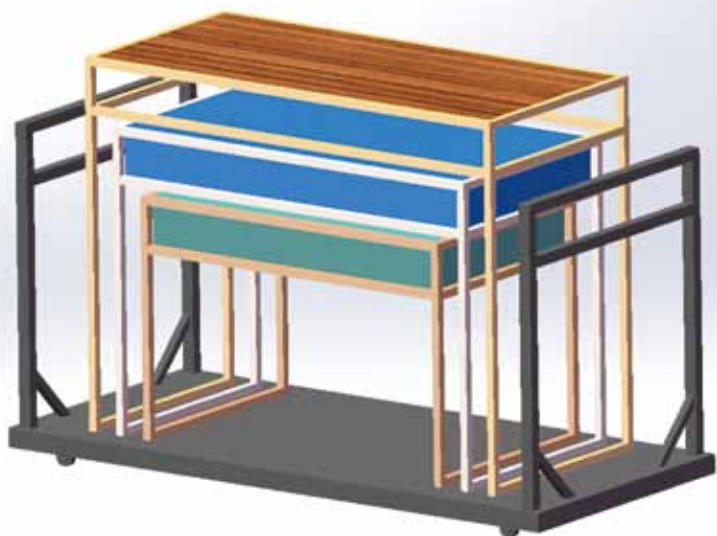

SCC.B-F107
Size:1960x800x1040

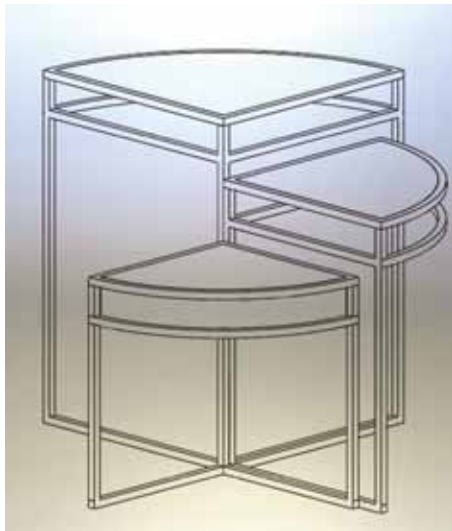

SCC.B-F101
Size:1500x700x750/950/1150

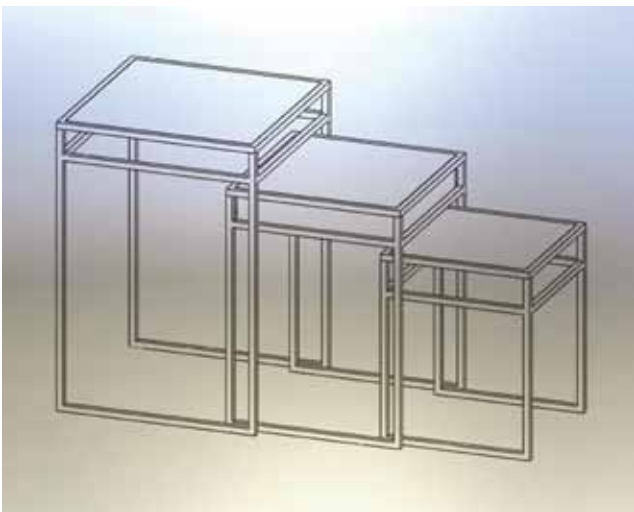

SCC.B-F103
Size:1000x1000x750/950/1150



SCC.B-F102
Size:800x750/950/1150

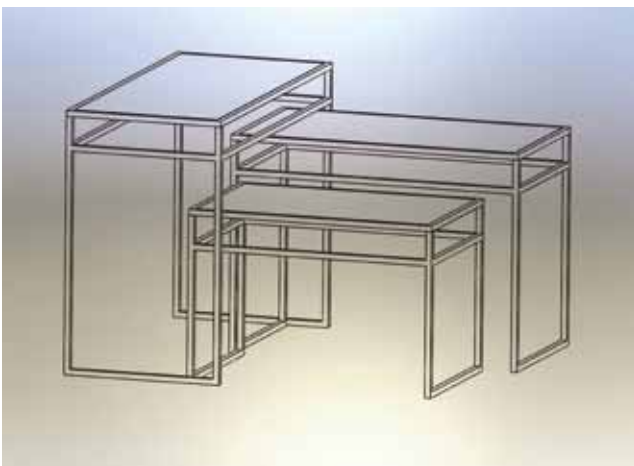

SCC.B-F105
Size:1500x700x750/950/1150

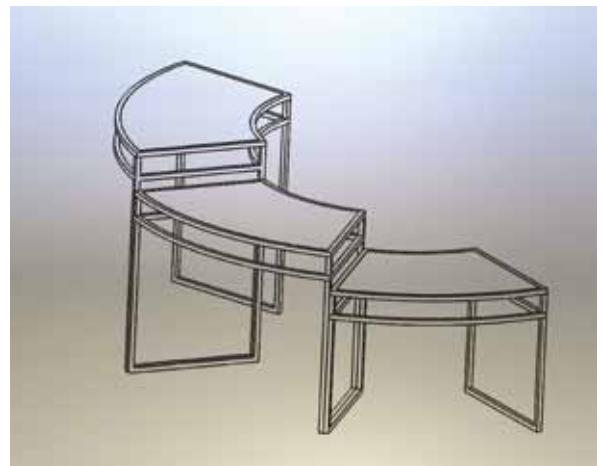

SCC.B-F104
Size:800x750/950/1150

SCC.B-G

茶歇台系列 *Tea break table series*



SCC.B-G101
Size:1500x500x900



SCC.B-G102
Size:750x800/950/1100



SCC.B-G103
Size:800x500x800/1000/1200



SCC.B-G104
Size:500x800/1000/1200



SCC.B-G105
 Size:900x650x660
 1100x650x850
 1300x650x1200



SCC.B-G107
 Size:625x625x655
 735x735x860
 850x850x1050



SCC.B-G106
 Size:550x550x1800



SCC.B-G108
 Size:1020x600x660
 1160x730x860
 1300x860x1060

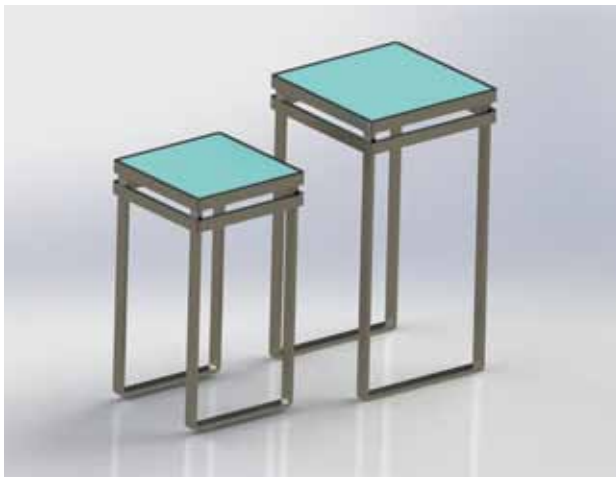

SCC.B-G109
 Size:550x550x1000
 650x650x1200

SCC.B-G

茶歇台系列 *Tea break table series*

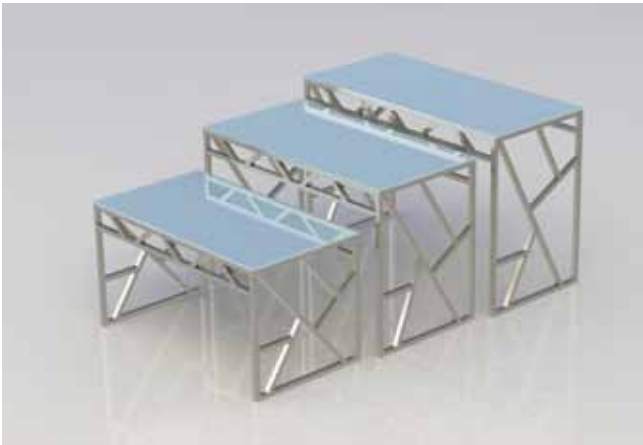

SCC.B-G110
Size:1200x650x660
1300x650x810
1400x650x960



SCC.B-G111
Size:550x550x1100
650x650x1200

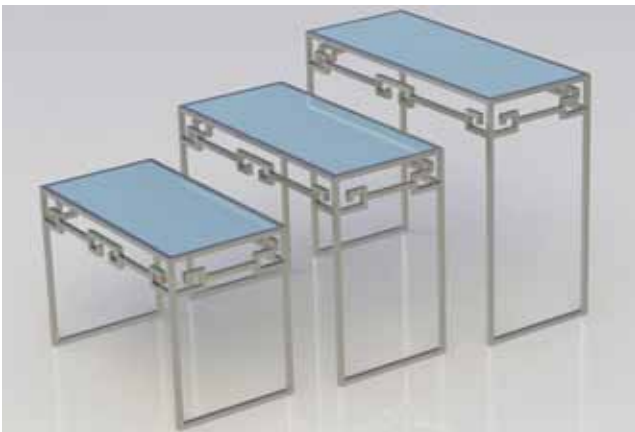

SCC.B-G112
Size:1150x600x800
1300x600x1000
1450x650x1200

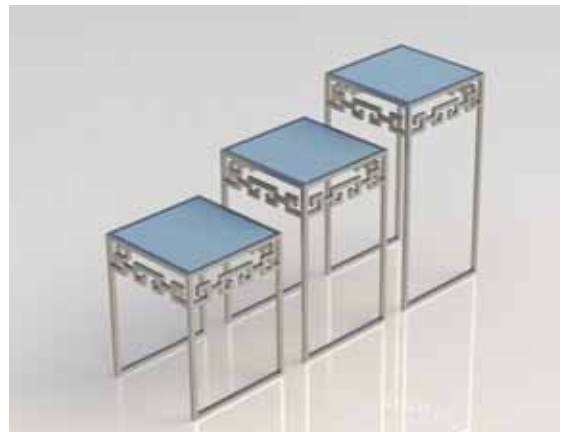

SCC.B-G113
Size:600x600x800
600x600x1000
600x600x1200



SCC.B-G114
Size:1200x700x650
1300x700x800
1400x700x960



SCC.B-G115
Size:550x550x1000
650x650x1200



SCC.B-G116
 Size:1200x650x650
 1300x650x800
 1400x650x950



SCC.B-G117
 Size:550x550x1100
 650x650x1200



SCC.B-G118
 Size:1200x650x650
 1300x650x800
 1400x650x950



SCC.B-G119
 Size:1200x650x650
 1300x650x800
 1400x650x950

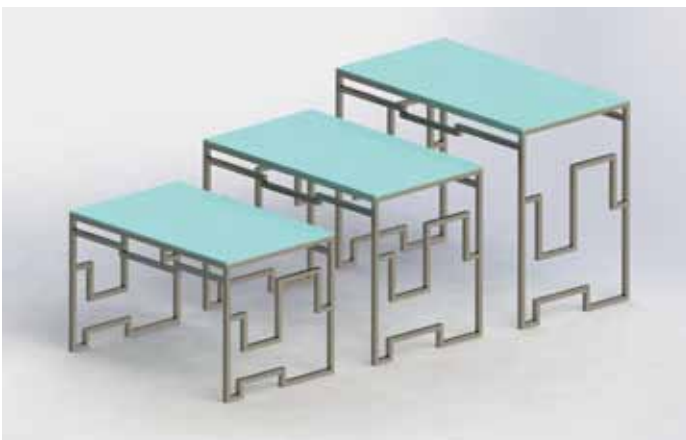

SCC.B-G120
 Size:1200x650x650
 1300x650x800
 1400x650x950

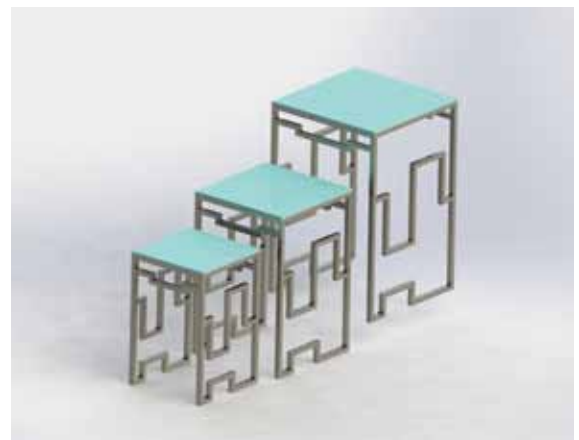

SCC.B-G121
 Size:450x450x700
 550x550x850
 650x650x1000

SCC.B-G

茶歇台系列 *Tea break table series*



SCC.B-G122
Size:650x650x810



SCC.B-G123
Size:1200x650x650
1300x650x800
1400x650x1050



SCC.B-G124
Size:740x740x700
840x840x830
980x980x950



SCC.B-G125
Size:450x450x810
550x550x1010
650x650x1210



SCC.B-G126
Size:1200x650x660
1300x650x810
1400x650x960



SCC.B-G127A
Size:780xx1100

SCC.B-G127B
Size:780xx1100



SCC.B-G128
Size: 60x 45x1050



SCC.B-G129
Size:1200x650x660
1300x650x810
1400x650x960

SCC.B-G

茶歇台系列 *Tea break table series*



SCC.B-G130
Size:1400x450x1900



SCC.B-G131
Size:1200x700x1730

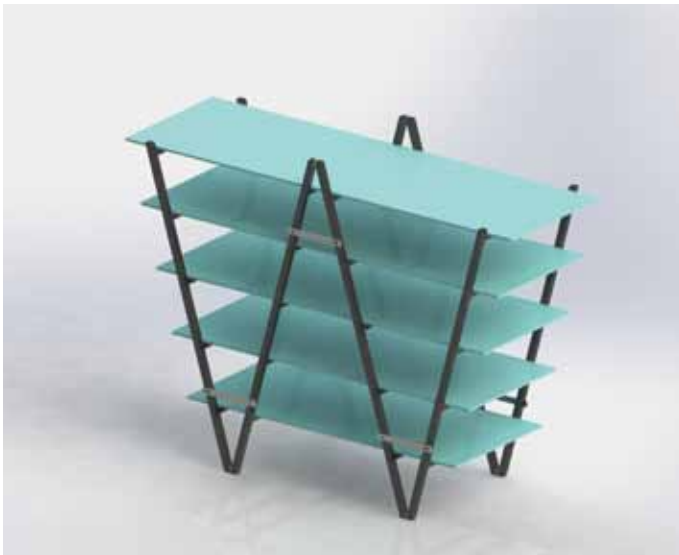

SCC.B-G132
Size:2200x700x1600



SCC.B-G133
Size:1600x500x2000



SCC.B-G134A
 Size:1280x640x780
 1440x720x850
 1600x800x920

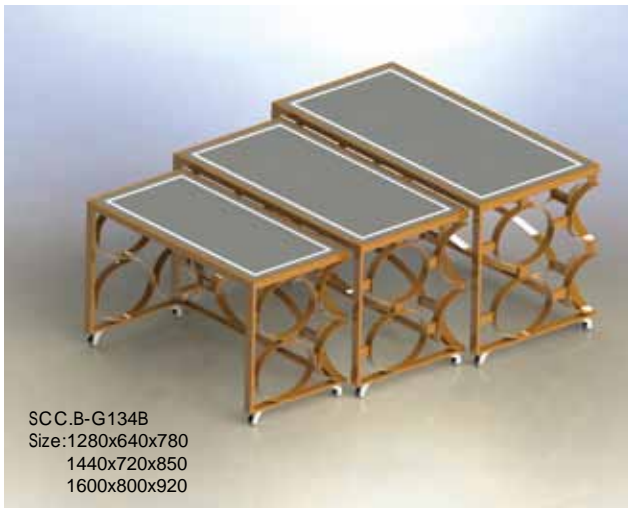

SCC.B-G134B
 Size:1280x640x780
 1440x720x850
 1600x800x920



SCC.B-G135B
 Size:1280x640x780
 1440x720x850
 1600x800x920



SCC.B-G

茶歇台系列 *Tea break table series*

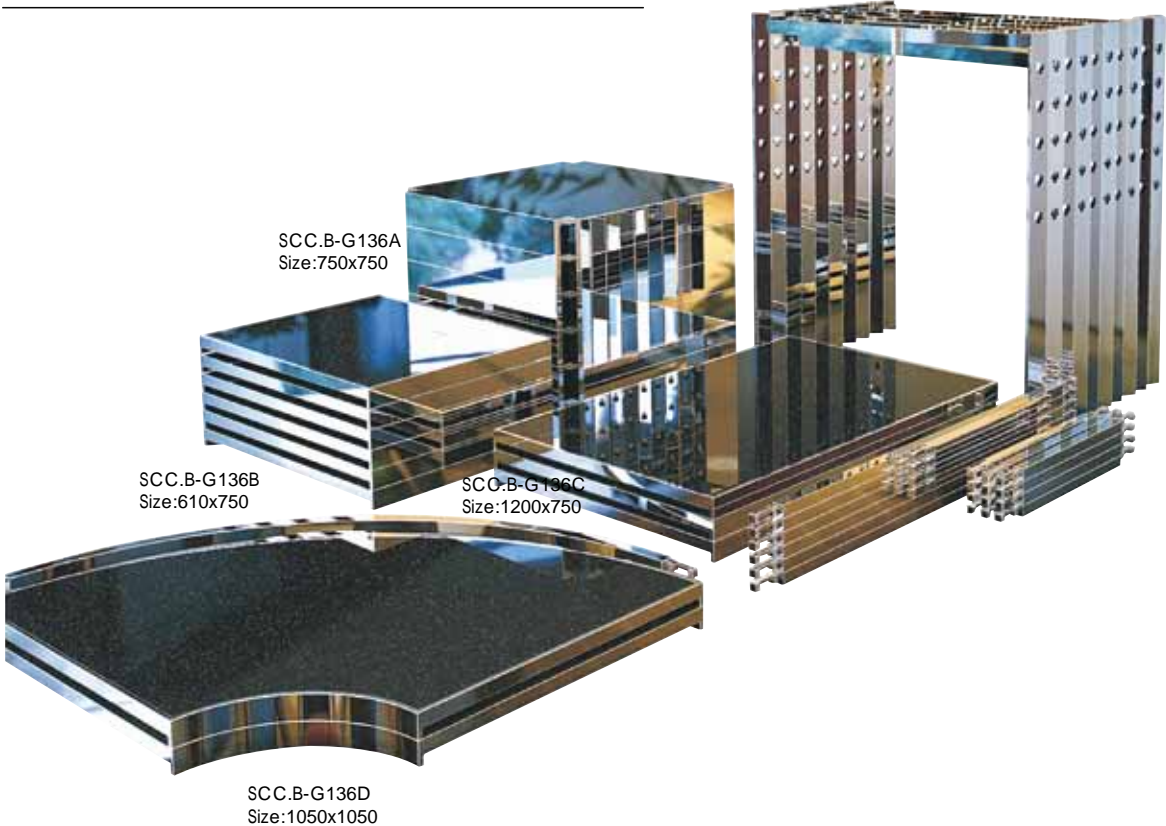

SCC.B-G136





SCC.B-G137A
 Size:1550x500x860
 1350x500x780
 1150x500x700



SCC.B-G137B
 Size:1550x500x860
 1350x500x780
 1150x500x700



SCC.B-G138
 Size:1500x800x800
 功能台

SCC.C-A 屏风系列

Screen series

尺寸功能可定做

The size and the function could be customized.



SCC.C-A101

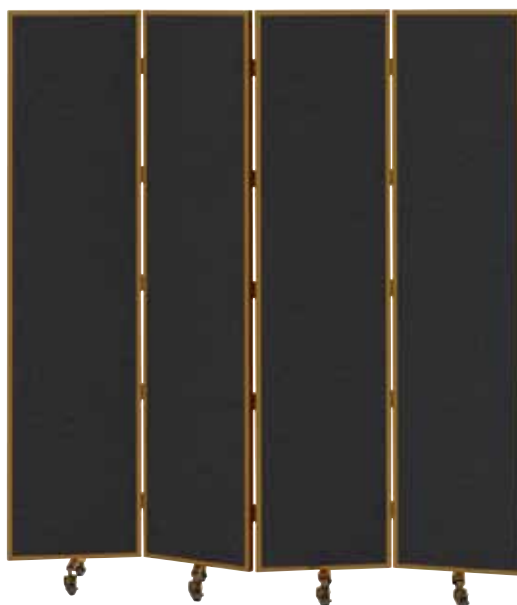

SCC.C-A102



SCC.C-A103A



SCC.C-A103B



SCC.C-A104B



SCC.C-A104A



SCC.C-A105



SCC.C-A106



SCC.C-A107

SCC.C-A 屏风系列

Screen series



SCC.C-A108



SCC.C-A109

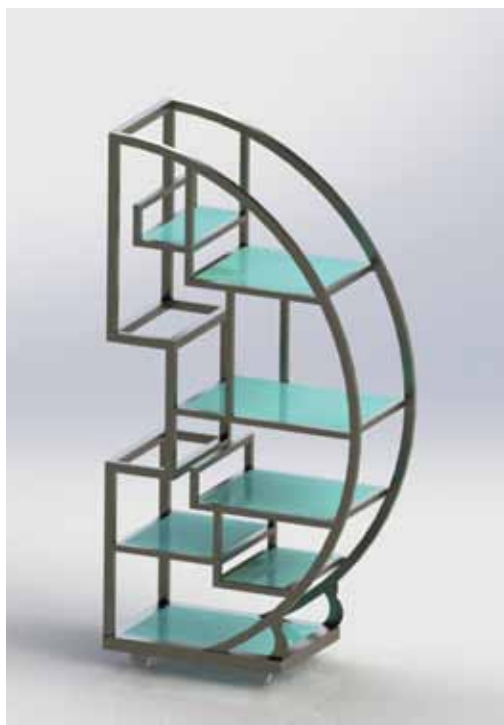

SCC.C-A110



SCC.C-A111



SCC.C-A112



SCC.C-A113

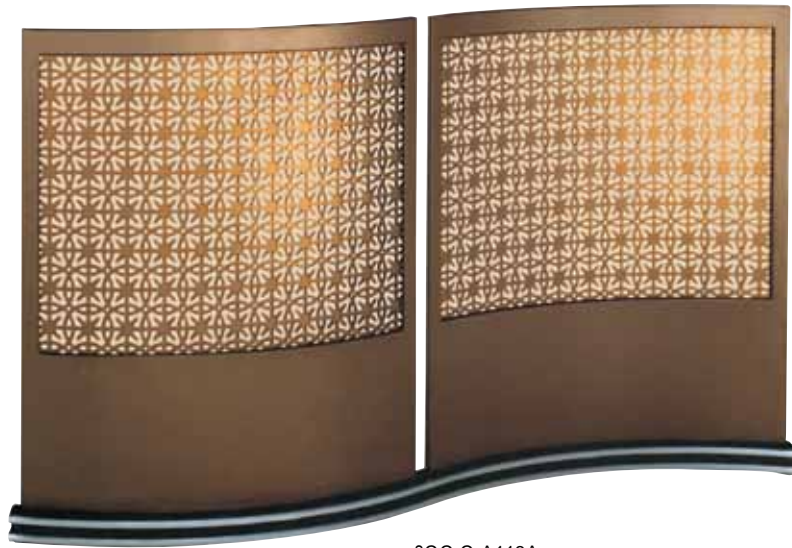

SCC.C-A113A

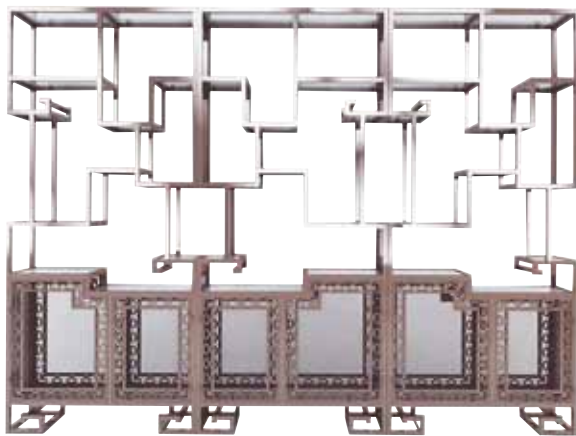

SCC.C-A114A

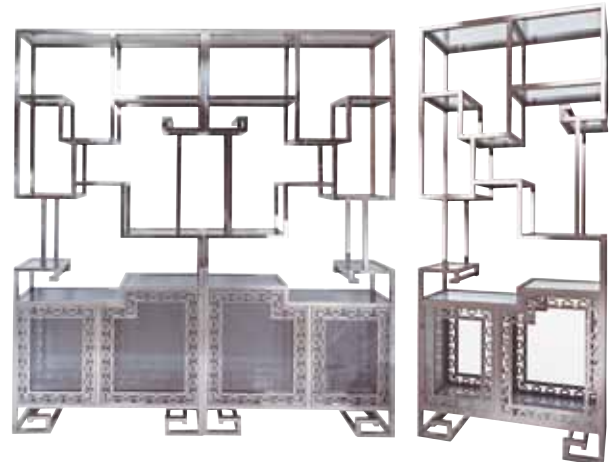

SCC.C-A114B

SCC.C-A 屏风系列

Screen series

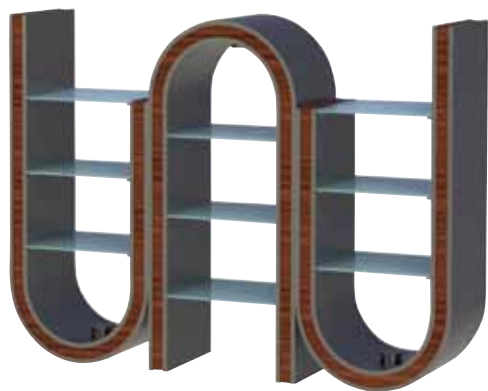

SCC.C-A115



SCC.C-A116

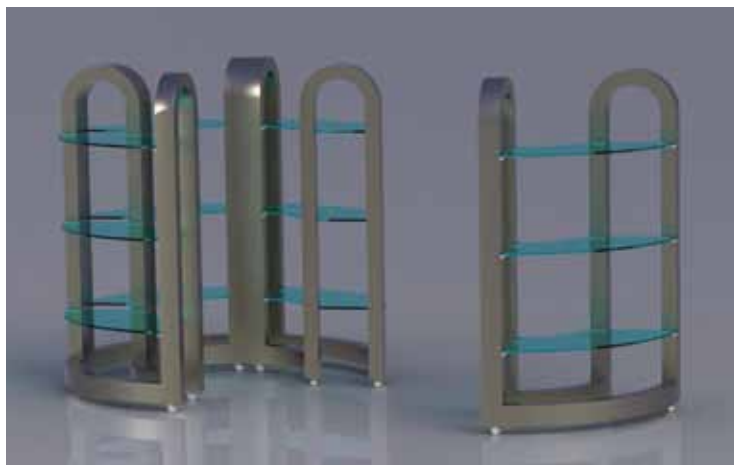

SCC.C-A117

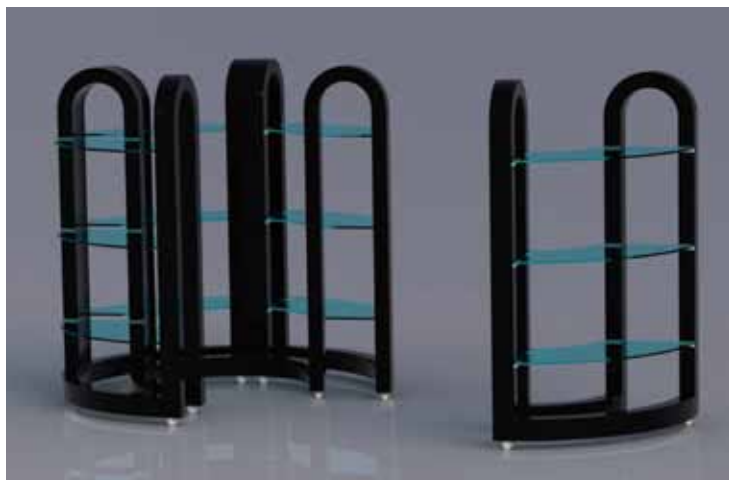

SCC.C-A118



SCC.C-A116
Size:2400x300x2200



SCC.C-A118
Size:2400x300x2200



SCC.C-A117
Size:2400x300x2200



SCC.C-A119
Size:2400x300x2200



SCC.C-A120
Size:2000x300x2200



SCC.C-A121
Size:2000x300x2200



SCC.C-A122
Size:2000x300x2200

SCC.C-B 屏风系列

Screen series



SCC.C-B101
Size:D1200x2000
Display cabinet
展示架



SCC.C-B102
Size:1800x540x2000
Display stand
展示架



SCC.C-B103
Size:1200x700x2000
Coffee Cabinet
咖啡服务柜



SCC.C-B104
Size:D980x1900
Coffee Cabinet
咖啡服务柜





SCC.C-B105
 Size:1300x700x2000
 Coffee Cabinet
 咖啡服务柜



SCC.C-B106
 Size:1200x700x2000
 Coffee Cabinet
 咖啡服务柜



SCC.C-B107
 Size:900x900x2000
 Coffee Cabinet
 咖啡服务柜

SCC.D-A

餐车系列
Dinner trolley series

Color For Wood Grain
木纹选项

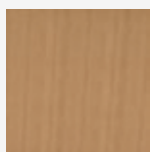

A



B



C

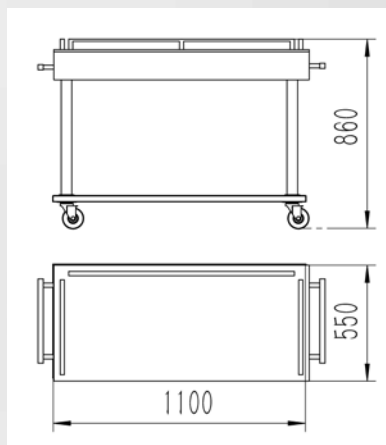



SCC.D-A-102
Size:1150x550x1470
Beef Cutting Trolley
牛肉车



Size:1150x550x65
Removable
活动盘



SCC.D-A-101
Size:1150x550x860
Service Trolley
服务车



SCC.D-A-104
Size:1150x550x860
Cooking Trolley
煮食车



SCC.D-A-103
Size:1150x550x860
Tea Trolley
茶车



SCC.D-A-105
Size:1450x550x1350
Dessert Trolley
甜点车



Liquor Trolley
酒车

SCC.D-B 餐车系列
Dinner trolley series

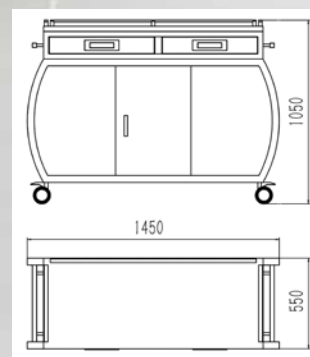

Color For Wood Grain
木纹选项



A



B



C



SCC.D-B-102
Size:1450x550x1680
Beef Cutting Trolley
牛肉车



Size:1550x550x65
Removable
活动盘



SCC.D-B-101
Size:1450x550x1050
Service Trolley
服务车



SCC.D-B-104
Size:1450x550x1050
Cooking Trolley
煮食车



SCC.D-B-103
Size:1450x550x1050
Tea Trolley
茶车



SCC.D-B-106
Size:1450x550x1350
Dessert Trolley
甜点车



SCC.D-B-105
Size:1450x550x1050
Liquor Trolley
酒车

SCC.D-C

餐车系列
Dinner trolley series



Color For Wood Grain
木纹选项

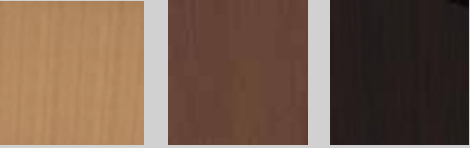

A

B

C

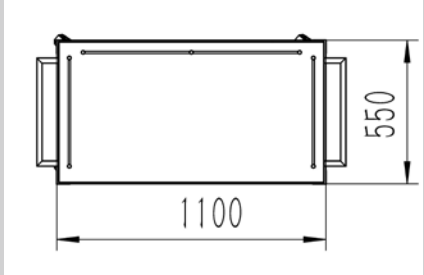
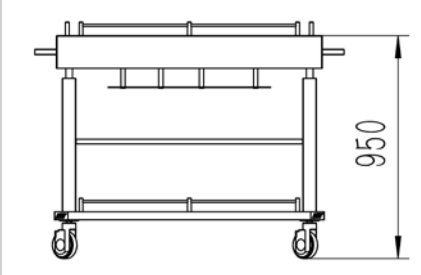



Size:1150x550x65
Removable
活动盘



SCC.D-C-102
Size:1150x550x1560
Beef Cutting Trolley
牛肉车



SCC.D-C-101
Size:1150x550x950
Service Trolley
服务车



SCC.D-C-104
Size:1150x550x950
Cooking Trolley
煮食车



SCC.D-C-103
Size:1150x550x950
Tea Trolley
茶车



SCC.D-C-106
Size:1150x550x1200
Dessert Trolley
甜点车



SCC.D-C-105
Size:1150x550x950
Liquor Trolley
酒车

SCC.D-D

餐车系列
Dinner trolley series



Color For Wood Grain
木纹选项



A

B

C

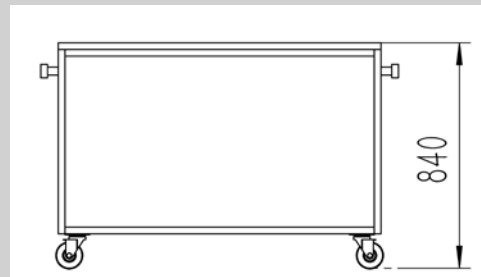
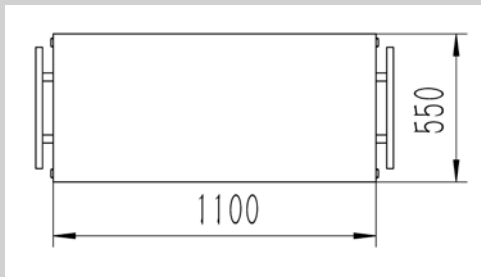



SCC.A-DF 餐车系列

Dinner trolley series

Color For Wood Grain

木纹选项



A



B



C

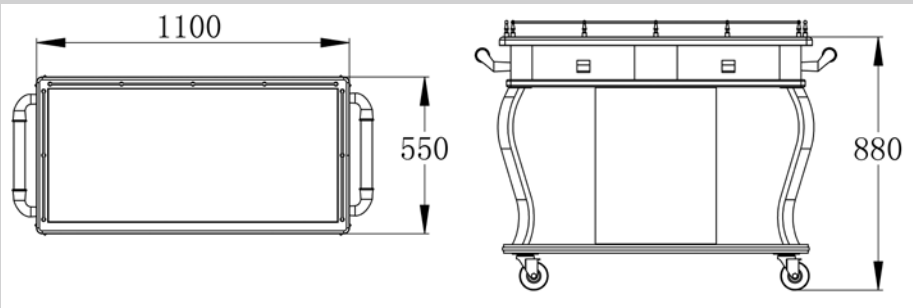



SCC.D-E-101
Size:1130x550x780
Service Trolley
服务车



SCC.D-E-102
Size:1130x550x1390
Beef Cutting Trolley
牛肉车



SCC.D-E-106
Size:1130x550x780
Liquor Trolley
酒车



SCC.D-E-103
Size:1130x550x780
Tea Trolley
茶车



SCC.D-E-104
Size:1130x550x1010
Dessert Trolley
甜点车



SCC.D-E-105
Size:1130x550x780
Cooking Trolley
煮食车



SCC.D-F-101

Color For Wood Grain
木纹选项



SCC.D-F-102

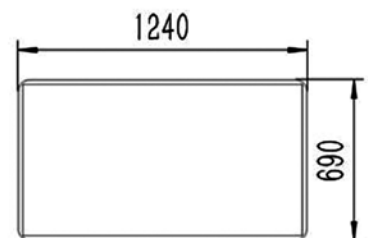
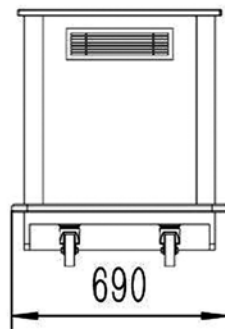
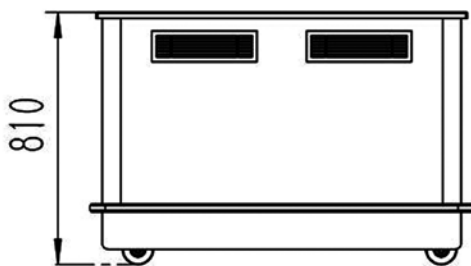



SCC.D-F-104



SCC.D-F-103



SCC.D-F-105

SCC.D-G 户外可移动售卖车系列

Refreshment Trailer series



SCC.D-G101
Size:2200x900x900/2200
Refreshment Trailer
户外可移动售卖车



SCC.D-G102
Size:2300x1700x900/2100
Refreshment Trailer
户外可移动售卖车



SCC.D-G103
 Size:2200x900x900/2200
 Refreshment Trailer
 户外可移动售卖车



SCC.D-G105
 Size:2500x1800x2500
 Refreshment Trailer
 户外可移动售卖车



SCC.D-G104
 Size:2200x900x900/2200
 Refreshment Trailer
 户外可移动售卖车

SCC.E- LED 系列
LED series

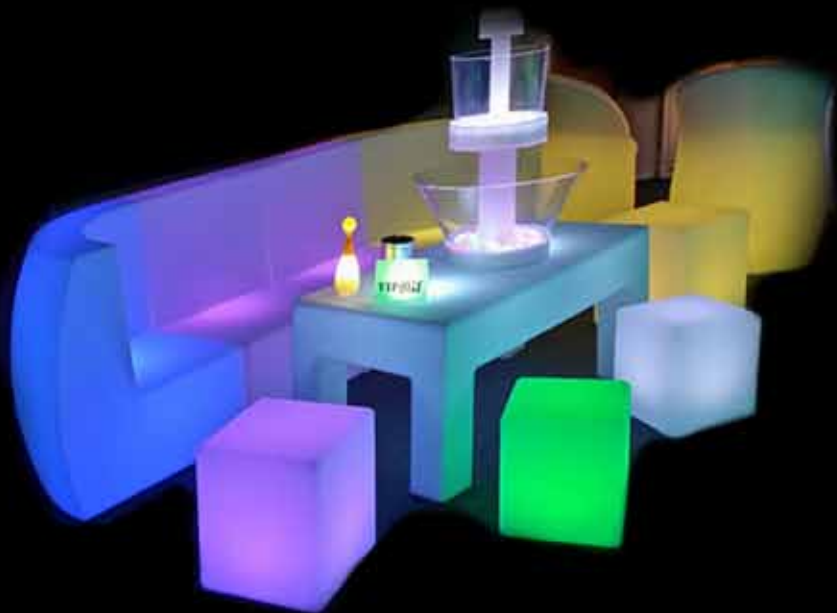

SCC.E-101
Size:1200x600xH450



SCC.E-102
Size:800x700xH700



SCC.E-103
Size:800x700xH700
800x750xH750



SCC.E-104
Size:200x200xH200
300x300xH300
400x400xH400
500x500xH500
600x600xH600



SCC.E-105
Size: 320x360xH270



SCC.E-106
Size: 310x310xH400



SCC.E-107
Size: 380x750
500x1000



SCC.E-108
Size: 680x1100xH900



SCC.E-109
Size: \varnothing 300xH400
 \varnothing 380xH900



SCC.E-110
Size: 400x400xH500
450x450xH700
380x380xH760



SCC.E-111
Size: 420x420xH150



SCC.E-112
Size: 180xH500



SCC.E-113
Size: \varnothing 600xH650
 \varnothing 480xH960



SCC.E-114
Size: 180xH500



SCC.E-115
Size: 270x110xH250
230x140xH450
360x140xH650

SCC.E-116
Size: 200
250
300
350
400
500
600
800



SCC.E-117
Size: \varnothing 320xH200
 \varnothing 350xH270



SCC.E-118
Size: \varnothing 260xH360
 \varnothing 300xH420



SCC.E-119
Size: \varnothing 110xH200
 \varnothing 200xH360

SCC.E- LED 系列

LED series

SCC.E-120
 Size: \varnothing 160xH200
 \varnothing 160xH240
 \varnothing 160xH360
 300x300xH800
 300x300xH1150
 \varnothing 380xH1150



SCC.E-121
 Size: 200x200xH200
 300x300xH300
 430x430xH430
 500x500xH500
 600x600xH600
 800x800xH800



室内室外大型摆件



SCC.E-122
 Size: \varnothing 600xH200
 \varnothing 800xH220



SCC.E-123
 Size: 1200x430xH430
 1210x540xH540



SCC.E-124
 Size: \varnothing 400xH390



SCC.E-125
 Size: \varnothing 750xH430



SCC.E-126
 Size: \varnothing 450xH680



SCC.E-127
 Size: \varnothing 600xH1060



SCC.E-128
Size:1500x400xH1000



SCC.E-129
Size:1140x810xH1100



SCC.E-130
Size:560x500xH1100
580x580xH1120



SCC.E-131
Size:1500x400xH1020



SCC.E-132
Size:1150x800xH1100



SCC.E-134
Size:1600x650xH1060



SCC.E-135
Size: ∅ 620xH680



SCC.E-133
Size: ∅ 600xH960



SCC.E-136
Size:1000x1000xH720

SCC.E- LED 系列

LED series



SCC.E-137
Size:560x560xH1100
580x580xH1120



SCC.E-138
Size:900x800xH1100



SCC.E-139
Size:1140x810xH1100



SCC.E-140
Size:500x480xH800



SCC.E-141
Size:600xH560
600xH760
600xH960
600xH1060
800x800xH560
800x800xH1060



SCC.E-142
Size:1100x460xH1060



SCC.E-143
Size:400x600xH830



SCC.E-144
Size:400x600xH730



SCC.E-145
Size:450x450xH1100



SCC.E-147
Size:500x500xH1200







嵌入式折叠系列 *Build-in Foldable Series*

Product introduction on page 产品介绍所在页面: P 001-003

PICTURE 图片	NAME 品名	CODR 编码	SIZE 尺寸	VOLTAGE/POWER 电压/功率
	F&B Display Station 食品展示台	SCC. A-A101	1700*710*880mm	220V/500W
	Western Style Carving Traditional Station 西式牛肉台	SCC. A-A102	1700*710*880mm	220V/2645W
	Noodle Station 煮面台	SCC. A-A103	1700*710*880mm	220V/4200W
	Soup Station 汤台	SCC. A-A104	1700*710*880mm	220V/3800W
	Induction Holding Station 电磁炉台	SCC. A-A105	1700*710*880mm	220V/6800W
	Roast Meat Station 烧腊台	SCC. A-A106	1700*710*880mm	220V/2900W
	Sushi Station 寿司台	SCC. A-A107	1700*710*880mm	220V/500W
	Dim-sum Station 点心台	SCC. A-A108	1700*710*880mm	220V/5800W
	Ice Cream Tepanyaki Station 炒冰台	SCC. A-A109	1700*710*880mm	220V/1200W
	Chotolate Fountain Station 巧克力喷泉台	SCC. A-A110	1700*710*880mm	220V/500W
	Multi Purpose Station 多功能台	SCC. A-A111	1700*710*880mm	220V/200W
	Induction Cooking Station 烹调台	SCC. A-A112	1700*710*880mm	220V/3800W
	Plate Warmer Side Station 附台 (暖碟)	SCC. A-A113	1700*710*880mm	220V/200W
	Induction Side Station 附台 (电磁炉)	SCC. A-A114	1700*710*880mm	220V/6000W
	Station F&B Display 附台 (冰盘) Side	SCC. A-A115	1700*710*880mm	220V/2645W
	Side Station Plain 附台	SCC. A-A116	1700*710*880mm	220V/1200W

折叠系列 - 配件 *Foldable Series (Accessories)*

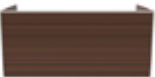
Product introduction on page 产品介绍所在页面: P 001-003



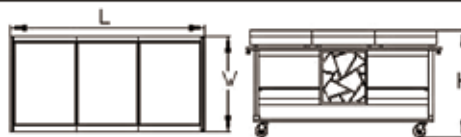

PICTURE 图片	NAME 品名	CODR 编码	SIZE 尺寸
	LED Board LED 灯箱	SCC. A-A117	600*540*29mm
	LED Board LED 灯箱 (底板)	SCC. A-A118	1900*740*29mm
	LED Board LED 灯箱 (侧面)	SCC. A-A119	714*601*29mm
	LED Board LED 灯箱 (正面)	SCC. A-A120	1874*351*29mm
	Folding Cover Panel 折叠挡板	SCC. A-A121	1990*800*726mm
	Folding Buffet Table Trolley 折叠布菲车推车	SCC. A-A122	800*680*1815mm
	Module Trolley 模块推车	SCC. A-A123	1750*800*1760mm

模块式折叠系列 *Modnlar Foldable Series*

Product introduction on page 产品介绍所在页: P 004-005

PICTURE 图片	NAME 品名	CODR 编码	SIZE 尺寸	VOLTAGE/POWER 电压/功率
	F&B Display Station 食品展示台	SCC. A-JB101	1700*800*850mm	220V/500W
	Western Style Carving Traditional Station 西式牛肉台	SCC. A-JB102	1700*800*850mm	220V/2645W
	Noodle Station 煮面台	SCC. A-JB103	1700*800*850mm	220V/4200W
	Soup Station 汤台	SCC. A-JB104	1700*800*850mm	220V/3800W
	Induction Holding Station 电磁炉台	SCC. A-JB105	1700*800*850mm	220V/6800W
	Roast Meat Station 烧腊台	SCC. A-JB106	1700*800*850mm	220V/2900W
	Sushi Station 寿司台	SCC. A-JB107	1700*800*850mm	220V/500W
	Dim-Sum Station 广东早茶台	SCC. A-JB108	1700*800*850mm	220V/5800W
	Ice Cream Tepanyaki Station 炒冰台	SCC. A-JB109	1700*800*850mm	220V/1200W
	Chotolate Fountain Station 巧克力喷泉台	SCC. A-JB110	1700*800*850mm	220V/500W
	Multi Purpose Station 多功能台	SCC. A-JB111	1700*800*850mm	220V/200W
	Induction Cooking Station 烹调台	SCC. A-JB112	1700*800*850mm	220V/3800W
	Induction Side Station 附台 (电磁炉)	SCC. A-JB113	800*800*850mm	220V/2400W
	Plate Warmer Side Station 附台 (暖碟)	SCC. A-JB114	800*800*850mm	220V/600W
	Side Station F&B Display 附台 (冰盘)	SCC. A-JB115	800*800*850mm	220V/500W
	Side Station Plain 附台	SCC. A-JB116	800*800*850mm	220V/200W

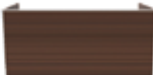
模块式折叠系列 – 配件 *Modnlar Foldable Series (Accessories)*

Product introduction on page 产品介绍所在页面: P 004-005

PICTURE 图片	NAME 品名	CODR 编码	SIZE 尺寸
	LED Board LED 灯箱	SCC. A-JB117	455*410*29mm
	Aster Structure 脚轮框架	SCC. A-JB118	1575*675*155mm
	Platfond For Buffet Station 户外顶棚	SCC. A-JB119	1710*800*1550mm
	Folding Cover Panel 折叠挡板	SCC. A-JB120	1615*695*726mm
	Folding Buffet Table Trolley 折叠布菲车推车	SCC. A-JB121	800*680*1815mm
	Modele Trolley 模块推车	SCC. A-JB122	1750*800*1760mm

七彩星光系列 *Colorful Light Star Series*

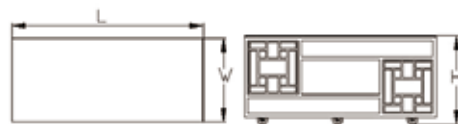

Product introduction on page 产品介绍所在页面: P 006-007

PICTURE 图片	NAME 品名	CODR 编码	SIZE 尺寸	VOLTAGE/POWER 电压/功率
	F&B Display Station 食品展示台	SCC. A-JC101	1800*800*850mm	220V/500W
	Western Style Carving Traditional Station 西式牛肉台	SCC. A-JC102	1800*800*850mm	220V/2645W
	Noodle Station 煮面台	SCC. A-JC103	1800*800*850mm	220V/4200W
	Soup Station 汤台	SCC. A-JC104	1800*800*850mm	220V/3800W
	Induction Holding Station 电磁炉台	SCC. A-JC105	1800*800*850mm	220V/6800W
	Roast Meat Station 烧腊台	SCC. A-JC106	1800*800*850mm	220V/2900W
	Sushi Station 寿司台	SCC. A-JC107	1800*800*850mm	220V/500W
	Dim-Sum Station 广东早茶台	SCC. A-JC108	1800*800*850mm	220V/5800W
	Ice Cream Tepanyaki Station 炒冰台	SCC. A-JC109	1800*800*850mm	220V/1200W
	Chotolate Fountain Station 巧克力喷泉台	SCC. A-JC110	1800*800*850mm	220V/500W
	Multi Purpose Station 多功能台	SCC. A-JC111	1800*800*850mm	220V/200W
	Induction Cooking Station 烹调台	SCC. A-JC112	1800*800*850mm	220V/3800W
	Induction Side Station 附台 (电磁炉)	SCC. A-JC113	800*800*850mm	220V/2400W
	Plate Warmer Side Station 附台 (暖碟)	SCC. A-JC114	800*800*850mm	220V/600W
	Side Station F&B Display 附台 (冰盘)	SCC. A-JC115	800*800*850mm	220V/500W
	Side Station Plain 附台	SCC. A-JC116	800*800*850mm	220V/200W



Product introduction on page 产品介绍所在页面: P 008-009

PICTURE 图片	NAME 品名	CODR 编码	SIZE 尺寸	VOLTAGE/POWER 电压/功率
	F&B Display Station 食品展示台	SCC. A-JD101	1740*1010*850mm	220V/500W
	Western Style Carving Traditional Station 西式牛肉台	SCC. A-JD102	1740*1010*850mm	220V/2645W
	Noodle Station 煮面台	SCC. A-JD103	1740*1010*850mm	220V/4200W
	Soup Station 汤台	SCC. A-JD104	1740*1010*850mm	220V/3800W
	Induction Holding Station 电磁炉台	SCC. A-JD105	1740*1010*850mm	220V/6800W
	Roast Meat Station 烧腊台	SCC. A-JD106	1740*1010*850mm	220V/2900W
	Sushi Station 寿司台	SCC. A-JD107	1740*1010*850mm	220V/500W
	Dim-Sum Station 广东早茶台	SCC. A-JD108	1740*1010*850mm	220V/5800W
	Ice Cream Tepanyaki Station 炒冰台	SCC. A-JD109	1740*1010*850mm	220V/1200W
	Chotolate Fountain Station 巧克力喷泉台	SCC. A-JD110	1740*1010*850mm	220V/500W
	Multi Purpose Station 多功能台	SCC. A-JD111	1740*1010*850mm	220V/200W
	Induction Cooking Station 烹调台	SCC. A-JD112	1740*1010*850mm	220V/3800W
	Induction Side Station 附台 (电磁炉)	SCC. A-JD113	D850*850mm	220V/2400W
	Plate Warmer Side Station 附台 (暖碟)	SCC. A-JD114	D850*850mm	220V/600W
	Side Station F&B Display 附台 (冰盘)	SCC. A-JD115	D850*850mm	220V/500W
	Side Station Plain 附台	SCC. A-JD116	D850*850mm	220V/200W

梦幻海洋系列 *Fantasy-sea Series*







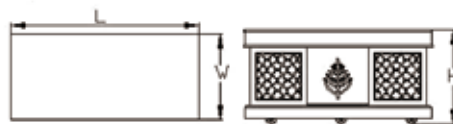









Product introduction on page 产品介绍所在页面: P010-011

PICTURE 图片	NAME 品名	CODR 编码	SIZE 尺寸	VOLTAGE/POWER 电压/功率
	F&B Display Station 食品展示台	SCC. A-JE101	1800*800*850mm	220V/500W
	Western Style Carving Traditional Station 西式牛肉台	SCC. A-JE102	1800*800*850mm	220V/2645W
	Noodle Station 煮面台	SCC. A-JE103	1800*800*850mm	220V/4200W
	Soup Station 汤台	SCC. A-JE104	1800*800*850mm	220V/3800W
	Induction Holding Station 电磁炉台	SCC. A-JE105	1800*800*850mm	220V/6800W
	Roast Meat Station 烧腊台	SCC. A-JE106	1800*800*850mm	220V/2900W
	Sushi Station 寿司台	SCC. A-JE107	1800*800*850mm	220V/500W
	Dim-Sum Station 广东早茶台	SCC. A-JE108	1800*800*850mm	220V/5800W
	Ice Cream Tepanyaki Station 炒冰台	SCC. A-JE109	1800*800*850mm	220V/1200W
	Chotolate Fountain Station 巧克力喷泉台	SCC. A-JE110	1800*800*850mm	220V/500W
	Multi Purpose Station 多功能台	SCC. A-JE111	1800*800*850mm	220V/200W
	Induction Cooking Station 烹调台	SCC. A-JE112	1800*800*850mm	220V/3800W
	Induction Side Station 附台 (电磁炉)	SCC. A-JE113	800*800*850mm	220V/2400W
	Plate Warmer Side Station 附台 (暖碟)	SCC. A-JE114	800*800*850mm	220V/600W
	Side Station F&B Display 附台 (冰盘)	SCC. A-JE115	800*800*850mm	220V/500W
	Side Station Plain 附台	SCC. A-JE116	800*800*850mm	220V/200W



Product introduction on page 产品介绍所在页面: P012-013

PICTURE 图片	NAME 品名	CODR 编码	SIZE 尺寸	VOLTAGE/POWER 电压/功率
	F&B Display Station 食品展示台	SCC. A-JF101	1800*800*850mm	220V/500W
	Western Style Carving Traditional Station 西式牛肉台	SCC. A-JF102	1800*800*850mm	220V/2645W
	Noodle Station 煮面台	SCC. A-JF103	1800*800*850mm	220V/4200W
	Soup Station 汤台	SCC. A-JF104	1800*800*850mm	220V/3800W
	Induction Holding Station 电磁炉台	SCC. A-JF105	1800*800*850mm	220V/6800W
	Roast Meat Station 烧腊台	SCC. A-JF106	1800*800*850mm	220V/2900W
	Sushi Station 寿司台	SCC. A-JF107	1800*800*850mm	220V/500W
	Dim-Sum Station 广东早茶台	SCC. A-JF108	1800*800*850mm	220V/5800W
	Ice Cream Tepanyaki Station 炒冰台	SCC. A-JF109	1800*800*850mm	220V/1200W
	Chotolate Fountain Station 巧克力喷泉台	SCC. A-JF110	1800*800*850mm	220V/500W
	Multi Purpose Station 多功能台	SCC. A-JF111	1800*800*850mm	220V/200W
	Induction Cooking Station 烹调台	SCC. A-JF112	1800*800*850mm	220V/3800W
	Induction Side Station 附台 (电磁炉)	SCC. A-JF113	800*800*850mm	220V/2400W
	Plate Warmer Side Station 附台 (暖碟)	SCC. A-JF114	800*800*850mm	220V/600W
	Side Station F&B Display 附台 (冰盘)	SCC. A-JF115	800*800*850mm	220V/500W
	Side Station Plain 附台	SCC. A-JF116	800*800*850mm	220V/200W

商务木纹系列 (标准台) *Commerce (Wood Grain) Series (Standard Station)*

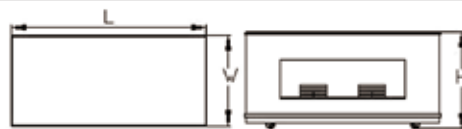

Product introduction on page 产品介绍所在页面: P014-015

PICTURE 图片	NAME 品名	CODR 编码	SIZE 尺寸	VOLTAGE/POWER 电压/功率
	F&B Display Station 食品展示台	SCC. A-JG101	1800*800*850mm	220V/500W
	Western Style Carving Traditional Station 西式牛肉台	SCC. A-JG102	1800*800*850mm	220V/2645W
	Noodle Station 煮面台	SCC. A-JG103	1800*800*850mm	220V/4200W
	Soup Station 汤台	SCC. A-JG104	1800*800*850mm	220V/3800W
	Induction Holding Station 电磁炉台	SCC. A-JG105	1800*800*850mm	220V/6800W
	Roast Meat Station 烧腊台	SCC. A-JG106	1800*800*850mm	220V/2900W
	Sushi Station 寿司台	SCC. A-JG107	1800*800*850mm	220V/500W
	Dim-Sum Station 广东早茶台	SCC. A-JG108	1800*800*850mm	220V/5800W
	Ice Cream Tepanyaki Station 炒冰台	SCC. A-JG109	1800*800*850mm	220V/1200W
	Chotolate Fountain Station 巧克力喷泉台	SCC. A-JG110	1800*800*850mm	220V/500W
	Multi Purpose Station 多功能台	SCC. A-JG111	1800*800*850mm	220V/200W
	Induction Cooking Station 烹调台	SCC. A-JG112	1800*800*850mm	220V/3800W
	Induction Side Station 附台 (电磁炉)	SCC. A-JG113	800*800*850mm	220V/2400W
	Plate Warmer Side Station 附台 (暖碟)	SCC. A-JG114	800*800*850mm	220V/600W
	Side Station F&B Display 附台 (冰盘)	SCC. A-JG115	800*800*850mm	220V/500W
	Side Station Plain 附台	SCC. A-JG116	800*800*850mm	220V/200W

商务木纹系列（扇形台）Commerce (Wood Grain) Series (Fan-shaped Station)

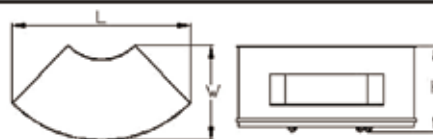

Product introduction on page 产品介绍所在页面: P014-015

PICTURE 图片	NAME 品名	CODR 编码	SIZE 尺寸	VOLTAGE/POWER 电压/功率
	F&B Display Station 食品展示台	SCC. A-JG117	1800*940*850mm	220V/500W
	Western Style Carving Traditional Station 西式牛肉台	SCC. A-JG118	1800*940*850mm	220V/2645W
	Noodle Station 煮面台	SCC. A-JG119	1800*940*850mm	220V/4200W
	Soup Station 汤台	SCC. A-JG120	1800*940*850mm	220V/3800W
	Induction Holding Station 电磁炉台	SCC. A-JG121	1800*940*850mm	220V/6800W
	Roast Meat Station 烧腊台	SCC. A-JG122	1800*940*850mm	220V/2900W
	Sushi Station 寿司台	SCC. A-JG123	1800*940*850mm	220V/500W
	Dim-Sum Station 广东早茶台	SCC. A-JG124	1800*940*850mm	220V/5800W
	Ice Cream Tepanyaki Station 炒冰台	SCC. A-JG125	1800*940*850mm	220V/1200W
	Chotolate Fountain Station 巧克力喷泉台	SCC. A-JG126	1800*940*850mm	220V/500W
	Multi Purpose Station 多功能台	SCC. A-JG127	1800*940*850mm	220V/200W
	Induction Cooking Station 烹调台	SCC. A-JG128	1800*940*850mm	220V/3800W
	Induction Side Station 附台（电磁炉）	SCC. A-JG129	800*800*850mm	220V/2400W
	Plate Warmer Side Station 附台（暖碟）	SCC. A-JG130	800*800*850mm	220V/600W
	Side Station F&B Display 附台（冰盘）	SCC. A-JG131	800*800*850mm	220V/500W
	Side Station Plain 附台	SCC. A-JG132	800*800*850mm	220V/200W

Product introduction on page 产品介绍所在页面: P 016-017

PICTURE 图片	NAME 品名	CODR 编码	SIZE 尺寸	VOLTAGE/POWER 电压/功率
	F&B Display Station 食品展示台	SCC. A-JH101	1800*850*850mm	220V/500W
	Western Style Carving Traditional Station 西式牛肉台	SCC. A-JH102	1800*850*850mm	220V/2645W
	Noodle Station 煮面台	SCC. A-JH103	1800*850*850mm	220V/4200W
	Soup Station 汤台	SCC. A-JH104	1800*850*850mm	220V/3800W
	Induction Holding Station 电磁炉台	SCC. A-JH105	1800*850*850mm	220V/6800W
	Roast Meat Station 烧腊台	SCC. A-JH106	1800*850*850mm	220V/2900W
	Sushi Station 寿司台	SCC. A-JH107	1800*850*850mm	220V/500W
	Dim-Sum Station 广东早茶台	SCC. A-JH108	1800*850*850mm	220V/5800W
	Ice Cream Tepanyaki Station 炒冰台	SCC. A-JH109	1800*850*850mm	220V/1200W
	Chotolate Fountain Station 巧克力喷泉台	SCC. A-JH110	1800*850*850mm	220V/500W
	Multi Purpose Station 多功能台	SCC. A-JH111	1800*850*850mm	220V/200W
	Induction Cooking Station 烹调台	SCC. A-JH112	1800*850*850mm	220V/3800W
	Induction Side Station 附台 (电磁炉)	SCC. A-JH113	850*850*850mm	220V/2400W
	Plate Warmer Side Station 附台 (暖碟)	SCC. A-JH114	850*850*850mm	220V/600W
	Side Station F&B Display 附台 (冰盘)	SCC. A-JH115	850*850*850mm	220V/500W
	Side Station Plain 附台	SCC. A-JH116	850*850*850mm	220V/200W



Product introduction on page 产品介绍所在页: P 018-019

PICTURE 图片	NAME 品名	CODR 编码	SIZE 尺寸	VOLTAGE/POWER 电压/功率
	F&B Display Station 食品展示台	SCC. A-JI101	1800*800*850mm	220V/500W
	Western Style Carving Traditional Station 西式牛肉台	SCC. A-JI102	1800*800*850mm	220V/2645W
	Noodle Station 煮面台	SCC. A-JI103	1800*800*850mm	220V/4200W
	Soup Station 汤台	SCC. A-JI104	1800*800*850mm	220V/3800W
	Induction Holding Station 电磁炉台	SCC. A-JI105	1800*800*850mm	220V/6800W
	Roast Meat Station 烧腊台	SCC. A-JI106	1800*800*850mm	220V/2900W
	Sushi Station 寿司台	SCC. A-JI107	1800*800*850mm	220V/500W
	Dim-Sum Station 广东早茶台	SCC. A-JI108	1800*800*850mm	220V/5800W
	Ice Cream Tepanyaki Station 炒冰台	SCC. A-JI109	1800*800*850mm	220V/1200W
	Chotolate Fountain Station 巧克力喷泉台	SCC. A-JI110	1800*800*850mm	220V/500W
	Multi Purpose Station 多功能台	SCC. A-JI111	1800*800*850mm	220V/200W
	Induction Cooking Station 烹调台	SCC. A-JI112	1800*800*850mm	220V/3800W
	Induction Side Station 附台 (电磁炉)	SCC. A-JI113	800*800*850mm	220V/2400W
	Plate Warmer Side Station 附台 (暖碟)	SCC. A-JI114	800*800*850mm	220V/600W
	Side Station F&B Display 附台 (冰盘)	SCC. A-JI115	800*800*850mm	220V/500W
	Side Station Plain 附台	SCC. A-JI116	800*800*850mm	220V/200W

轻质纤维系列 *Light Fiber Series*

Product introduction on page 产品介绍所在页面: P 020-021

PICTURE 图片	NAME 品名	CODR 编码	SIZE 尺寸	VOLTAGE/POWER 电压/功率
	F&B Display Station 食品展示台	SCC. A-JJ101	1800*800*850mm	220V/500W
	Western Style Carving Traditional Station 西式牛肉台	SCC. A-JJ102	1800*800*850mm	220V/2645W
	Noodle Station 煮面台	SCC. A-JJ103	1800*800*850mm	220V/4200W
	Soup Station 汤台	SCC. A-JJ104	1800*800*850mm	220V/3800W
	Induction Holding Station 电磁炉台	SCC. A-JJ105	1800*800*850mm	220V/6800W
	Roast Meat Station 烧腊台	SCC. A-JJ106	1800*800*850mm	220V/2900W
	Sushi Station 寿司台	SCC. A-JJ107	1800*800*850mm	220V/500W
	Dim-Sum Station 广东早茶台	SCC. A-JJ108	1800*800*850mm	220V/5800W
	Ice Cream Tepanyaki Station 炒冰台	SCC. A-JJ109	1800*800*850mm	220V/1200W
	Chotolate Fountain Station 巧克力喷泉台	SCC. A-JJ110	1800*800*850mm	220V/500W
	Multi Purpose Station 多功能台	SCC. A-JJ111	1800*800*850mm	220V/200W
	Induction Cooking Station 烹调台	SCC. A-JJ112	1800*800*850mm	220V/3800W
	Induction Side Station 附台 (电磁炉)	SCC. A-JJ113	800*800*850mm	220V/2400W
	Plate Warmer Side Station 附台 (暖碟)	SCC. A-JJ114	800*800*850mm	220V/600W
	Side Station F&B Display 附台 (冰盘)	SCC. A-JJ115	800*800*850mm	220V/500W
	Side Station Plain 附台	SCC. A-JJ116	800*800*850mm	220V/200W

轻质纤维系列（扇形台） *Light Fiber Series (Fan-shaped station)*

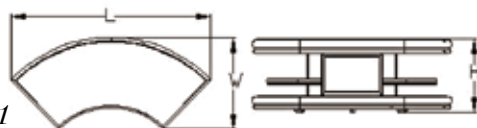

Product introduction on page 产品介绍所在页面: P 020-021

PICTURE 图片	NAME 品名	CODR 编码	SIZE 尺寸	VOLTAGE/POWER 电压/功率
	F&B Display Station 食品展示台	SCC. A-JJ117	2370*1050*850mm	220V/500W
	Western Style Carving Traditional Station 西式牛肉台	SCC. A-JJ118	2370*1050*850mm	220V/2645W
	Noodle Station 煮面台	SCC. A-JJ119	2370*1050*850mm	220V/4200W
	Soup Station 汤台	SCC. A-JJ120	2370*1050*850mm	220V/3800W
	Induction Holding Station 电磁炉台	SCC. A-JJ121	2370*1050*850mm	220V/6800W
	Roast Meat Station 烧腊台	SCC. A-JJ122	2370*1050*850mm	220V/2900W
	Sushi Station 寿司台	SCC. A-JJ123	2370*1050*850mm	220V/500W
	Dim-Sum Station 广东早茶台	SCC. A-JJ124	2370*1050*850mm	220V/5800W
	Ice Cream Tepanyaki Station 炒冰台	SCC. A-JJ125	2370*1050*850mm	220V/1200W
	Chotolate Fountain Station 巧克力喷泉台	SCC. A-JJ126	2370*1050*850mm	220V/500W
	Multi Purpose Station 多功能台	SCC. A-JJ127	2370*1050*850mm	220V/200W
	Induction Cooking Station 烹调台	SCC. A-JJ128	2370*1050*850mm	220V/3800W
	Induction Side Station 附台（电磁炉）	SCC. A-JJ129	1290*870*850mm	220V/2400W
	Plate Warmer Side Station 附台（暖碟）	SCC. A-JJ130	1290*870*850mm	220V/600W
	Side Station F&B Display 附台（冰盘）	SCC. A-JJ131	1290*870*850mm	220V/500W
	Side Station Plain 附台	SCC. A-JJ132	1290*870*850mm	220V/200W

椭圆系列 *Oval Shape Series*

Product introduction on page 产品介绍所在页面: P022-023

PICTURE 图片	NAME 品名	CODR 编码	SIZE 尺寸	VOLTAGE/POWER 电压/功率
	F&B Display Station 食品展示台	SCC. A-JK101	2000*850*850mm	220V/500W
	Western Style Carving Traditional Station 西式牛肉台	SCC. A-JK102	2000*850*850mm	220V/2645W
	Noodle Station 煮面台	SCC. A-JK103	2000*850*850mm	220V/4200W
	Soup Station 汤台	SCC. A-JK104	2000*850*850mm	220V/3800W
	Induction Holding Station 电磁炉台	SCC. A-JK105	2000*850*850mm	220V/6800W
	Roast Meat Station 烧腊台	SCC. A-JK106	2000*850*850mm	220V/2900W
	Sushi Station 寿司台	SCC. A-JK107	2000*850*850mm	220V/500W
	Dim-Sum Station 广东早茶台	SCC. A-JK108	2000*850*850mm	220V/5800W
	Ice Cream Tepanyaki Station 炒冰台	SCC. A-JK109	2000*850*850mm	220V/1200W
	Chocolate Fountain Station 巧克力喷泉台	SCC. A-JK110	2000*850*850mm	220V/500W
	Multi Purpose Station 多功能台	SCC. A-JK111	2000*850*850mm	220V/200W
	Induction Cooking Station 烹调台	SCC. A-JK112	2000*850*850mm	220V/3800W
	Induction Side Station 附台 (电磁炉)	SCC. A-JK113	D850*850mm	220V/2400W
	Side Station Plain 附台 (高)	SCC. A-JK114	D850*1010mm	220V/200W
	Side Station Plain 附台 (标准)	SCC. A-JK115	D850*850mm	220V/200W
	Side Station Plain 附台 (矮)	SCC. A-JK116	D850*690mm	220V/200W

全实木系列 *Solid Wood Series*

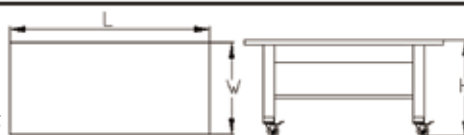

Product introduction on page 产品介绍所在页面: P024-025

PICTURE 图片	NAME 品名	CODR 编码	SIZE 尺寸	VOLTAGE/POWER 电压/功率
	F&B Display Station 食品展示台	SCC. A-JL101	1800*800*850mm	220V/500W
	Western Style Carving Traditional Station 西式牛肉台	SCC. A-JL102	1800*800*850mm	220V/2645W
	Noodle Station 煮面台	SCC. A-JL103	1800*800*850mm	220V/4200W
	Soup Station 汤台	SCC. A-JL104	1800*800*850mm	220V/3800W
	Induction Holding Station 电磁炉台	SCC. A-JL105	1800*800*850mm	220V/6800W
	Roast Meat Station 烧腊台	SCC. A-JL106	1800*800*850mm	220V/2900W
	Sushi Station 寿司台	SCC. A-JL107	1800*800*850mm	220V/500W
	Dim-Sum Station 广东早茶台	SCC. A-JL108	1800*800*850mm	220V/5800W
	Ice Cream Tepanyaki Station 炒冰台	SCC. A-JL109	1800*800*850mm	220V/1200W
	Chotolate Fountain Station 巧克力喷泉台	SCC. A-JL110	1800*800*850mm	220V/500W
	Multi Purpose Station 多功能台	SCC. A-JL111	1800*800*850mm	220V/200W
	Induction Cooking Station 烹调台	SCC. A-JL112	1800*800*850mm	220V/3800W
	Grill/Flat Broiler Station 扒炉台	SCC. A-JL113	1800*800*850mm	220V/6000W
	Side Station Plain 附台 (高)	SCC. A-JL114	800*800*1135mm	220V/200W
	Side Station Plain 附台 (中)	SCC. A-JL115	800*800*935mm	220V/200W
	Side Station Plain 附台 (矮)	SCC. A-JL116	800*800*735mm	220V/200W

经典木艺系列（标准台） Classical Wooden Art Series (Standard Station)

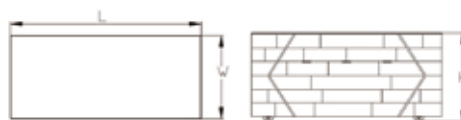

Product introduction on page 产品介绍所在页面: P 026-027

PICTURE 图片	NAME 品名	CODR 编码	SIZE 尺寸	VOLTAGE/POWER 电压/功率
	F&B Display Station 食品展示台	SCC. A-JM101	1800*800*850	220V/500W
	Western Style Carving Traditional Station 西式牛肉台	SCC. A-JM102	1800*800*850	220V/2645W
	Noodle Station 煮面台	SCC. A-JM103	1800*800*850	220V/4200W
	Soup Station 汤台	SCC. A-JM104	1800*800*850	220V/3800W
	Induction Holding Station 电磁炉台	SCC. A-JM105	1800*800*850	220V/6800W
	Roast Meat Station 烧腊台	SCC. A-JM106	1800*800*850	220V/2900W
	Sushi Station 寿司台	SCC. A-JM107	1800*800*850	220V/500W
	Dim-Sum Station 广东早茶台	SCC. A-JM108	1800*800*850	220V/5800W
	Ice Cream Tepanyaki Station 炒冰台	SCC. A-JM109	1800*800*850	220V/1200W
	Chotolate Fountain Station 巧克力喷泉台	SCC. A-JM110	1800*800*850	220V/500W
	Multi Purpose Station 多功能台	SCC. A-JM111	1800*800*850	220V/200W
	Induction Cooking Station 烹调台	SCC. A-JM112	1800*800*850	220V/3800W
	Induction Side Station 附台（电磁炉）	SCC. A-JM113	800*800*850mm	220V/2400W
	Plate Warmer Side Station 附台（暖碟）	SCC. A-JM114	800*800*850mm	220V/600W
	Side Station F&B Display 附台（冰盘）	SCC. A-JM115	800*800*850mm	220V/500W
	Side Station Plain 附台	SCC. A-JM116	800*800*850mm	220V/200W

经典木艺系列(扇形台) Classical Wooden Art Series(Fan-shaped Station)

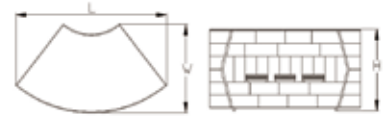

Product introduction on page 产品介绍所在页面: P 026-027

PICTURE 图片	NAME 品名	CODR 编码	SIZE 尺寸	VOLTAGE/POWER 电压/功率
	F&B Display Station 食品展示台	SCC. A-JM117	1800*940*850mm	220V/500W
	Western Style Carving Traditional Station 西式牛肉台	SCC. A-JM118	1800*940*850mm	220V/2645W
	Noodle Station 煮面台	SCC. A-JM119	1800*940*850mm	220V/4200W
	Soup Station 汤台	SCC. A-JM120	1800*940*850mm	220V/3800W
	Induction Holding Station 电磁炉台	SCC. A-JM121	1800*940*850mm	220V/6800W
	Roast Meat Station 烧腊台	SCC. A-JM122	1800*940*850mm	220V/2900W
	Sushi Station 寿司台	SCC. A-JM123	1800*940*850mm	220V/500W
	Dim-Sum Station 广东早茶台	SCC. A-JM124	1800*940*850mm	220V/5800W
	Ice Cream Tepanyaki Station 炒冰台	SCC. A-JM125	1800*940*850mm	220V/1200W
	Chotolate Fountain Station 巧克力喷泉台	SCC. A-JM126	1800*940*850mm	220V/500W
	Multi Purpose Station 多功能台	SCC. A-JM127	1800*940*850mm	220V/200W
	Induction Cooking Station 烹调台	SCC. A-JM128	1800*940*850mm	220V/3800W
	Induction Side Station 附台(电磁炉)	SCC. A-JM129	800*800*850mm	220V/2400W
	Plate Warmer Side Station 附台(暖碟)	SCC. A-JM130	800*800*850mm	220V/600W
	Side Station F&B Display 附台(冰盘)	SCC. A-JM131	800*800*850mm	220V/500W
	Side Station Plain 附台	SCC. A-JM132	800*800*850mm	220V/200W

弯钢系列 *Curve Metal Series*

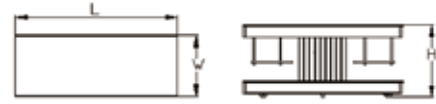



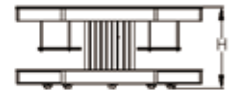

Product introduction on page 产品介绍所在页面: P 028-029

PICTURE 图片	NAME 品名	CODR 编码	SIZE 尺寸	VOLTAGE/POWER 电压/功率
	F&B Display Station 食品展示台	SCC. A-JN101	1800*800*850mm	220V/500W
	Western Style Carving Traditional Station 西式牛肉台	SCC. A-JN102	1800*800*850mm	220V/2645W
	Induction Holding Station With Spot Lights 电磁炉台带射灯	SCC. A-JN103	1800*800*850mm	220V/6800W
	Soup Station 汤台	SCC. A-JN104	1800*800*850mm	220V/3800W
	Induction Holding Station 电磁炉台	SCC. A-JN105	1800*800*850mm	220V/6800W
	Roast Meat Station 烧腊台	SCC. A-JN106	1800*800*850mm	220V/2900W
	Sushi Station 寿司台	SCC. A-JN107	1800*800*850mm	220V/500W
	Dim-Sum Station 广东早茶台	SCC. A-JN108	1800*800*850mm	220V/5800W
	Induction Holding Station With Heating Lamps 电磁炉台带灯	SCC. A-JN109	1800*800*850mm	220V/6800W
	Chotolate Fountain Station 巧克力喷泉台	SCC. A-JN110	1800*800*850mm	220V/500W
	Multi Purpose Station 多功能台	SCC. A-JN111	1800*800*850mm	220V/200W
	Induction Cooking Station 烹调台	SCC. A-JN112	1800*800*850mm	220V/3800W
	Induction Side Station 附台 (电磁炉)	SCC. A-JN113	800*800*850mm	220V/2400W
	Dim-Sum Side Station 附台 (点心)	SCC. A-JN114	800*800*850mm	220V/1900W
	Side Station F&B Display 附台 (冰盘)	SCC. A-JN115	800*800*850mm	220V/500W
	Side Station Plain 附台	SCC. A-JN116	800*800*850mm	220V/200W

弯钢系列（扇形台） *Curve Metal Series(Fan-shaped station)*



Product introduction on page 产品介绍所在页: P 028-029

PICTURE 图片	NAME 品名	CODR 编码	SICE 尺寸	VOLTAGE/POWER 电压/功率
	F&B Display Station 食品展示台	SCC. A-JN117	1975*900*850mm	220V/500W
	Western Style Carving Traditional Station 西式牛肉台	SCC. A-JN118	1975*900*850mm	220V/2645W
	Induction Holding Station 电磁炉台	SCC. A-JN119	1975*900*850mm	220V/6800W
	Soup Station 汤台	SCC. A-JN120	1975*900*850mm	220V/3800W
	Induction Holding Station With Spot Lights 电磁炉台带射灯	SCC. A-JN121	1975*900*850mm	220V/6800W
	Roast Meat Station 烧腊台	SCC. A-JN122	1975*900*850mm	220V/2900W
	Sushi Station 寿司台	SCC. A-JN123	1975*900*850mm	220V/500W
	Dim-Sum Station 广东早茶台	SCC. A-JN124	1975*900*850mm	220V/5800W
	Induction Holding Station With Heating Lamps 电磁炉台带灯	SCC. A-JN125	1975*900*850mm	220V/6800W
	Chotolate Fountain Station 巧克力喷泉台	SCC. A-JN126	1975*900*850mm	220V/500W
	Multi Purpose Station 多功能台	SCC. A-JN127	1975*900*850mm	220V/200W
	Induction Cooking Station 烹调台	SCC. A-JN128	1975*900*850mm	220V/3800W
	Induction Side Station 附台（电磁炉）	SCC. A-JN129	1070*750*850mm	220V/2400W
	Dim-Sum Side Station 附台（点心）	SCC. A-JN130	1070*750*850mm	220V/1900W
	Side Station F&B Display 附台（冰盘）	SCC. A-JN131	1070*750*850mm	220V/500W
	Side Station Plain 附台	SCC. A-JN132	1070*750*850mm	220V/200W

直钢系列 *Vertical Metal Series*

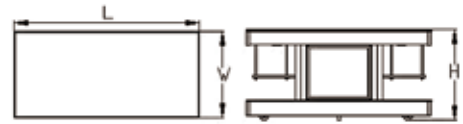

Product introduction on page 产品介绍所在页面: P 030-031

PICTURE 图片	NAME 品名	CODR 编码	SIZE 尺寸	VOLTAGE/POWER 电压/功率
	F&B Display Station 食品展示台	SCC. A-J0101	1800*800*850mm	220V/500W
	Western Style Carving Traditional Station 西式牛肉台	SCC. A-J0102	1800*800*850mm	220V/2645W
	Noodle Station 煮面台	SCC. A-J0103	1800*800*850mm	220V/4200W
	Soup Station 汤台	SCC. A-J0104	1800*800*850mm	220V/3800W
	Induction Holding Station 电磁炉台	SCC. A-J0105	1800*800*850mm	220V/6800W
	Roast Meat Station 烧腊台	SCC. A-J0106	1800*800*850mm	220V/2900W
	Sushi Station 寿司台	SCC. A-J0107	1800*800*850mm	220V/500W
	Dim-Sum Station 广东早茶台	SCC. A-J0108	1800*800*850mm	220V/5800W
	Ice Cream Tepanyaki Station 炒冰台	SCC. A-J0109	1800*800*850mm	220V/1200W
	Chotolate Fountain Station 巧克力喷泉台	SCC. A-J0110	1800*800*850mm	220V/500W
	Multi Purpose Station 多功能台	SCC. A-J0111	1800*800*850mm	220V/200W
	Induction Cooking Station 烹调台	SCC. A-J0112	1800*800*850mm	220V/3800W
	Induction Side Station 附台 (电磁炉)	SCC. A-J0113	800*800*850mm	220V/2400W
	Plate Warmer Side Station 附台 (暖碟)	SCC. A-J0114	800*800*850mm	220V/600W
	Side Station F&B Display 附台 (冰盘)	SCC. A-J0115	800*800*850mm	220V/500W
	Side Station Plain 附台	SCC. A-J0116	800*800*850mm	220V/200W

直钢系列（扇形台） *Vertical Metal Series (Fan-shaped station)*

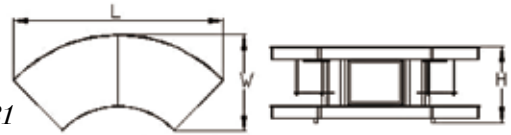

Product introduction on page 产品介绍所在页：P 030-031

PICTURE 图片	NAME 品名	CODR 编码	SIZE 尺寸	VOLTAGE/POWER 电压/功率
	F&B Display Station 食品展示台	SCC. A-J0117	2435*1070*850mm	220V/500W
	Western Style Carving Traditional Station 西式牛肉台	SCC. A-J0118	2435*1070*850mm	220V/2645W
	Noodle Station 煮面台	SCC. A-J0119	2435*1070*850mm	220V/4200W
	Soup Station 汤台	SCC. A-J0120	2435*1070*850mm	220V/3800W
	Induction Holding Station 电磁炉台	SCC. A-J0121	2435*1070*850mm	220V/6800W
	Roast Meat Station 烧腊台	SCC. A-J0122	2435*1070*850mm	220V/2900W
	Sushi Station 寿司台	SCC. A-J0123	2435*1070*850mm	220V/500W
	Dim-Sum Station 广东早茶台	SCC. A-J0124	2435*1070*850mm	220V/5800W
	Ice Cream Tepanyaki Station 炒冰台	SCC. A-J0125	2435*1070*850mm	220V/1200W
	Chotolate Fountain Station 巧克力喷泉台	SCC. A-J0126	2435*1070*850mm	220V/500W
	Multi Purpose Station 多功能台	SCC. A-J0127	2435*1070*850mm	220V/200W
	Induction Cooking Station 烹调台	SCC. A-J0128	2435*1070*850mm	220V/3800W
	Induction Side Station 附台（电磁炉）	SCC. A-J0129	1345*880*850mm	220V/2400W
	Plate Warmer Side Station 附台（暖碟）	SCC. A-J0130	1345*880*850mm	220V/600W
	Side Station F&B Display 附台（冰盘）	SCC. A-J0131	1345*880*850mm	220V/500W
	Side Station Plain 附台	SCC. A-J0132	1345*880*850mm	220V/200W

摩登系列 *Modern Series*

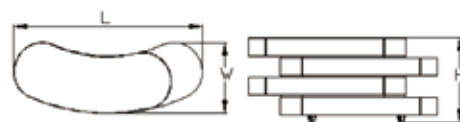

Product introduction on page 产品介绍所在页面: P 032-033

PICTURE 图片	NAME 品名	CODR 编码	SIZE 尺寸	VOLTAGE/POWER 电压/功率
	F&B Display Station 食品展示台	SCC. A-JP101	1975*740*850mm	220V/500W
	Western Style Carving Traditional Station 西式牛肉台	SCC. A-JP102	1975*740*850mm	220V/2645W
	Noodle Station 煮面台	SCC. A-JP103	1975*740*850mm	220V/4200W
	Soup Station 汤台	SCC. A-JP104	1975*740*850mm	220V/3800W
	Induction Holding Station 电磁炉台	SCC. A-JP105	1975*740*850mm	220V/6800W
	Roast Meat Station 烧腊台	SCC. A-JP106	1975*740*850mm	220V/2900W
	Sushi Station 寿司台	SCC. A-JP107	1975*740*850mm	220V/500W
	Dim-sum Station 点心台	SCC. A-JP108	1975*740*850mm	220V/5800W
	Ice Cream Tepanyaki Station 炒冰台	SCC. A-JP109	1975*740*850mm	220V/1200W
	Chotolate Fountain Station 巧克力喷泉台	SCC. A-JP110	1975*740*850mm	220V/500W
	Multi Purpose Station 多功能台	SCC. A-JP111	1975*740*850mm	220V/200W
	Induction Cooking Station 烹调台	SCC. A-JP112	1975*740*850mm	220V/3800W
	Sweet Station 甜点台	SCC. A-JP113	1975*740*850mm	220V/200W
	Grill/Flat Broiler Station 扒炉台	SCC. A-JP114	1975*740*850mm	220V/6000W
	Carving Station 传统牛肉台	SCC. A-JP115	1975*740*850mm	220V/2645W
	Plate Warmer Station 暖碟台	SCC. A-JP116	1975*740*850mm	220V/1200W

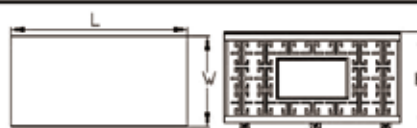

Product introduction on page 产品介绍所在页面: P034-035

PICTURE 图片	NAME 品名	CODR 编码	SIZE 尺寸	VOLTAGE/POWER 电压/功率
	F&B Display Station 食品展示台	SCC. A-JH101	1800*800*850mm	220V/500W
	Western Style Carving Traditional Station 西式牛肉台	SCC. A-JH102	1800*800*850mm	220V/2645W
	Noodle Station 煮面台	SCC. A-JH103	1800*800*850mm	220V/4200W
	Soup Station 汤台	SCC. A-JH104	1800*800*850mm	220V/3800W
	Induction Holding Station 电磁炉台	SCC. A-JH105	1800*800*850mm	220V/6800W
	Roast Meat Station 烧腊台	SCC. A-JH106	1800*800*850mm	220V/2900W
	Sushi Station 寿司台	SCC. A-JQ107	1800*800*850mm	220V/500W
	Dim-Sum Station 广东早茶台	SCC. A-JH108	1800*800*850mm	220V/5800W
	Ice Cream Tepanyaki Station 炒冰台	SCC. A-JH109	1800*800*850mm	220V/1200W
	Chotolate Fountain Station 巧克力喷泉台	SCC. A-JH110	1800*800*850mm	220V/500W
	Multi Purpose Station 多功能台	SCC. A-JH111	1800*800*850mm	220V/200W
	Induction Cooking Station 烹调台	SCC. A-JH112	1800*800*850mm	220V/3800W
	Induction Side Station 附台 (电磁炉)	SCC. A-JH113	800*800*850mm	220V/2400W
	Plate Warmer Side Station 附台 (暖碟)	SCC. A-JH114	800*800*850mm	220V/600W
	Side Station F&B Display 附台 (冰盘)	SCC. A-JH115	800*800*850mm	220V/500W
	Side Station Plain 附台	SCC. A-JH116	800*800*850mm	220V/200W

时尚系列 *Fashion Series*







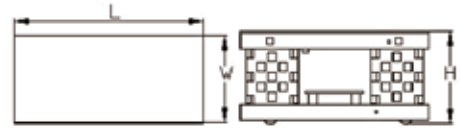











Product introduction on page 产品介绍所在页面: P036-037

PICTURE 图片	NAME 品名	CODR 编码	SIZE 尺寸	VOLTAGE/POWER 电压/功率
	F&B Display Station 食品展示台	SCC. A-JR101	1810*780*850mm	220V/500W
	Western Style Carving Traditional Station 西式牛肉台	SCC. A-JR102	1810*780*850mm	220V/2645W
	Noodle Station 煮面台	SCC. A-JR103	1810*780*850mm	220V/4200W
	Soup Station 汤台	SCC. A-JR104	1810*780*850mm	220V/3800W
	Induction Holding Station 电磁炉台	SCC. A-JR105	1810*780*850mm	220V/6800W
	Roast Meat Station 烧腊台	SCC. A-JR106	1810*780*850mm	220V/2900W
	Sushi Station 寿司台	SCC. A-JR107	1810*780*850mm	220V/500W
	Dim-Sum Station 广东早茶台	SCC. A-JR108	1810*780*850mm	220V/5800W
	Ice Cream Tepanyaki Station 炒冰台	SCC. A-JR109	1810*780*850mm	220V/1200W
	Chotolate Fountain Station 巧克力喷泉台	SCC. A-JR110	1810*780*850mm	220V/500W
	Multi Purpose Station 多功能台	SCC. A-JR111	1810*780*850mm	220V/200W
	Induction Cooking Station 烹调台	SCC. A-JR112	1810*780*850mm	220V/3800W
	Induction Side Station 附台 (电磁炉)	SCC. A-JR113	910*720*850mm	220V/2400W
	Plate Warmer Side Station 附台 (暖碟)	SCC. A-JR114	910*720*850mm	220V/600W
	Side Station F&B Display 附台 (冰盘)	SCC. A-JR115	910*720*850mm	220V/500W
	Side Station Plain 附台	SCC. A-JR116	910*720*850mm	220V/200W



Product introduction on page 产品介绍所在页面: P 038-039

PICTURE 图片	NAME 品名	CODR 编码	SIZE 尺寸	VOLTAGE/POWER 电压/功率
	F&B Display Station 食品展示台	SCC. A-JS101	1800*800*850	220V/500W
	Western Style Carving Traditional Station 西式牛肉台	SCC. A-JS102	1800*800*850	220V/2645W
	Noodle Station 煮面台	SCC. A-JS103	1800*800*850	220V/4200W
	Soup Station 汤台	SCC. A-JS104	1800*800*850	220V/3800W
	Induction Holding Station 电磁炉台	SCC. A-JS105	1800*800*850	220V/6800W
	Roast Meat Station 烧腊台	SCC. A-JS106	1800*800*850	220V/2900W
	Sushi Station 寿司台	SCC. A-JS107	1800*800*850	220V/500W
	Dim-Sum Station 广东早茶台	SCC. A-JS108	1800*800*850	220V/5800W
	Ice Cream Tepanyaki Station 炒冰台	SCC. A-JS109	1800*800*850	220V/1200W
	Chotolate Fountain Station 巧克力喷泉台	SCC. A-JS110	1800*800*850	220V/500W
	Multi Purpose Station 多功能台	SCC. A-JS111	1800*800*850	220V/200W
	Induction Cooking Station 烹调台	SCC. A-JS112	1800*800*850	220V/3800W
	Induction Side Station 附台 (电磁炉)	SCC. A-JS113	800*800*850	220V/2400W
	Plate Warmer Side Station 附台 (暖碟)	SCC. A-JS114	800*800*850	220V/600W
	Side Station F&B Display 附台 (冰盘)	SCC. A-JS115	800*800*850	220V/500W
	Side Station Plain 附台	SCC. A-JS116	800*800*850	220V/200W

皇室系列 *Royal Series*

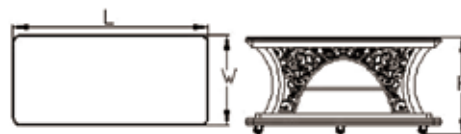

Product introduction on page 产品介绍所在页面: P 040-041

PICTURE 图片	NAME 品名	CODR 编码	SIZE 尺寸	VOLTAGE/POWER 电压/功率
	F&B Display Station 食品展示台	SCC. A-JT101	1800*800*850mm	220V/500W
	Western Style Carving Traditional Station 西式牛肉台	SCC. A-JT102	1800*800*850mm	220V/2645W
	Noodle Station 煮面台	SCC. A-JT103	1800*800*850mm	220V/4200W
	Soup Station 汤台	SCC. A-JT104	1800*800*850mm	220V/3800W
	Induction Holding Station 电磁炉台	SCC. A-JT105	1800*800*850mm	220V/6800W
	Roast Meat Station 烧腊台	SCC. A-JT106	1800*800*850mm	220V/2900W
	Sushi Station 寿司台	SCC. A-JT107	1800*800*850mm	220V/500W
	Dim-Sum Station 广东早茶台	SCC. A-JT108	1800*800*850mm	220V/5800W
	Ice Cream Tepanyaki Station 炒冰台	SCC. A-JT109	1800*800*850mm	220V/1200W
	Chotolate Fountain Station 巧克力喷泉台	SCC. A-JT110	1800*800*850mm	220V/500W
	Multi Purpose Station 多功能台	SCC. A-JT111	1800*800*850mm	220V/200W
	Induction Cooking Station 烹调台	SCC. A-JT112	1800*800*850mm	220V/3800W
	Induction Side Station 附台 (电磁炉)	SCC. A-JT113	800*800*850mm	220V/2400W
	Plate Warmer Side Station 附台 (暖碟)	SCC. A-JT114	800*800*850mm	220V/600W
	Side Station F&B Display 附台 (冰盘)	SCC. A-JT115	800*800*850mm	220V/500W
	Side Station Plain 附台	SCC. A-JT116	800*800*850mm	220V/200W



Product introduction on page 产品介绍所在页面: P042-043

PICTURE 图片	NAME 品名	CODR 编码	SIZE 尺寸	VOLTAGE/POWER 电压/功率
	F&B Display Station 食品展示台	SCC. A-JU101	1800*800*850mm	220V/500W
	Western Style Carving Traditional Station 西式牛肉台	SCC. A-JU102	1800*800*850mm	220V/2645W
	Noodle Station 煮面台	SCC. A-JU103	1800*800*850mm	220V/4200W
	Soup Station 汤台	SCC. A-JU104	1800*800*850mm	220V/3800W
	Induction Holding Station 电磁炉台	SCC. A-JU105	1800*800*850mm	220V/6800W
	Roast Meat Station 烧腊台	SCC. A-JU106	1800*800*850mm	220V/2900W
	Sushi Station 寿司台	SCC. A-JU107	1800*800*850mm	220V/500W
	Dim-Sum Station 广东早茶台	SCC. A-JU108	1800*800*850mm	220V/5800W
	Ice Cream Tepanyaki Station 炒冰台	SCC. A-JU109	1800*800*850mm	220V/1200W
	Chotolate Fountain Station 巧克力喷泉台	SCC. A-JU110	1800*800*850mm	220V/500W
	Multi Purpose Station 多功能台	SCC. A-JU111	1800*800*850mm	220V/200W
	Induction Cooking Station 烹调台	SCC. A-JU112	1800*800*850mm	220V/3800W
	Induction Side Station 附台 (电磁炉)	SCC. A-JU113	800*800*850mm	220V/2400W
	Plate Warmer Side Station 附台 (暖碟)	SCC. A-JU114	800*800*850mm	220V/600W
	Side Station F&B Display 附台 (冰盘)	SCC. A-JU115	800*800*850mm	220V/500W
	Side Station Plain 附台	SCC. A-JU116	800*800*850mm	220V/200W

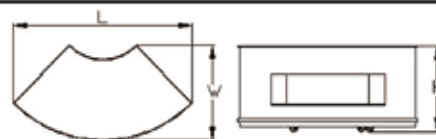
优雅系列（扇形台） *Elegance Series (Fan-shaped station)*

Product introduction on page 产品介绍所在页面: P042-043

PICTURE 图片	NAME 品名	CODR 编码	SIZE 尺寸	VOLTAGE/POWER 电压/功率
	F&B Display Station 食品展示台	SCC. A-JU117	1800*940*850mm	220V/500W
	Western Style Carving Traditional Station 西式牛肉台	SCC. A-JU118	1800*940*850mm	220V/2645W
	Noodle Station 煮面台	SCC. A-JU119	1800*940*850mm	220V/4200W
	Soup Station 汤台	SCC. A-JU120	1800*940*850mm	220V/3800W
	Induction Holding Station 电磁炉台	SCC. A-JU121	1800*940*850mm	220V/6800W
	Roast Meat Station 烧腊台	SCC. A-JU122	1800*940*850mm	220V/2900W
	Sushi Station 寿司台	SCC. A-JU123	1800*940*850mm	220V/500W
	Dim-Sum Station 广东早茶台	SCC. A-JU124	1800*940*850mm	220V/5800W
	Ice Cream Tepanyaki Station 炒冰台	SCC. A-JU125	1800*940*850mm	220V/1200W
	Chotolate Fountain Station 巧克力喷泉台	SCC. A-JU126	1800*940*850mm	220V/500W
	Multi Purpose Station 多功能台	SCC. A-JU127	1800*940*850mm	220V/200W
	Induction Cooking Station 烹调台	SCC. A-JU128	1800*940*850mm	220V/3800W
	Induction Side Station 附台（电磁炉）	SCC. A-JU129	800*800*850mm	220V/2400W
	Plate Warmer Side Station 附台（暖碟）	SCC. A-JU130	800*800*850mm	220V/600W
	Side Station F&B Display 附台（冰盘）	SCC. A-JU131	800*800*850mm	220V/500W
	Side Station Plain 附台	SCC. A-JU132	800*800*850mm	220V/200W